

SAVE VTR 300/B

Installation and Service

GB

Document in original language | 211475 · A001



© Copyright Systemair UAB

All rights reserved

E&OE

Systemair UAB reserves the rights to alter their products without notice.

This also applies to products already ordered, as long as it does not affect the previously agreed specifications.

Systemair is not liable or bound by the warranty if these instructions are not adhered to during installation or service.

Contents

1	Declaration of Conformity	1	7.6	Description of User function icons	13
2	Disposal and recycling	2	7.7	Main menu	14
3	Warnings.....	2	7.7.1	Unit Information.....	14
4	About this document.....	2	7.7.2	Alarms	15
5	Product information.....	2	7.7.3	Week Schedule.....	18
5.1	General.....	2	7.7.4	Filter	19
5.2	Left and Right models	3	7.7.5	System Preferences.....	20
5.3	Installation recommendation regarding condensation	3	7.7.6	Service	20
5.3.1	Condensation inside of the unit	3	7.7.7	Help.....	26
5.3.2	Condensation outside of the unit	3	8	Electrical connections.....	27
5.4	Transport and storage	4	8.1	Main board layout	27
5.5	Technical data	4	8.2	External connections (Connection board)	29
5.5.1	Dimensions and Weight, L model.....	4	9	Before starting the system.....	29
5.5.2	Dimensions and Weight, R model.....	5	10	Service	30
5.5.3	Duct connections.....	6	10.1	Warnings.....	30
5.5.4	Power consumption and fuse size	6	10.2	Internal components.....	31
6	Installation.....	6	10.2.1	Component descriptions	32
6.1	Unpacking	6	10.3	Replacing rotor drive belt	33
6.2	Where/how to install	7	10.3.1	Heat exchanger mounted	34
6.3	Installation procedure.....	7	10.3.2	Heat exchanger removed	34
6.3.1	How to remove and remount the heat exchanger.....	7	10.4	Troubleshooting.....	34
6.4	Condensation drainage	8	11	Accessories.....	36
7	SAVECair control	8	11.1	Internet Access Module (IAM).....	36
7.1	General.....	8	11.1.1	Mobile application and Login.....	36
7.2	Startup wizard	8	11.2	Indoor air quality sensors	36
7.3	Common symbols.....	8	11.3	Temperature control	38
7.4	Menu overview	9	11.3.1	Electrical duct pre- heater	38
7.5	Home screen.....	10	11.3.2	Internal water heater	39
7.5.1	User modes	10	11.3.3	Duct water heater	40
7.5.2	Temperature settings.....	12	11.3.4	Duct water cooler.....	42
7.5.3	Airflow settings	12	11.3.5	Change-over coil (DX)	43
7.5.4	Indoor Air Quality	13	11.4	Airflow control.....	44
7.5.5	Status line	13	11.4.1	VAV/CAV conversion kit.....	44
			11.5	Installation/Maintenance	45
			11.5.1	Outdoor/Exhaust air dampers.....	45

11.6 Filters 46
11.7 Passive House function..... 46

1 Declaration of Conformity

Manufacturer



Systemair UAB
 Linų st. 101
 LT-20174 Ukmergė, LITHUANIA
 Office: +370 340 60165 Fax: +370 340 60166
 www.systemair.com

hereby confirms that the following product:

Heat recovery ventilation unit: SAVE VTR 300/B

(The declaration applies only to product in the condition it was delivered in and installed in the facility in accordance with the included installation instructions. The insurance does not cover components that are added or actions carried out subsequently on the product).

Comply with all applicable requirements in the following directives:

- Machinery Directive 2006/42/EC
- Low Voltage Directive 2014/35/EU
- EMC Directive 2014/30/EU
- Ecodesign Directive 2009/125/EC

The following regulations are applied in applicable parts:

1253/2014	Requirements for ventilation units
1254/2014	Energy labelling of residential ventilation units
327/2011	Requirements for fans above 125 W

The following harmonized standards are applied in applicable parts:

EN ISO 12100:2010	Safety of machinery - General principles for design - Risk assessment and risk reduction
EN 13857	Safety of machinery - Safety distances to prevent hazard zones being reached by upper or lower limbs
EN 60 335-1	Household and similar electrical appliances - Safety Part 1: General requirements
EN 60 335-2-40	Safety of household and similar electrical appliances - Part 2-40: Particular requirements for electrical heat pumps, air-conditioners and dehumidifiers
EN 62233	Measurement methods for electromagnetic fields of household appliances and similar apparatus with regard to human exposure
EN 50 106:2007	Safety of household and similar appliances - Particular rules for routine tests referring to appliances under the scope of EN 60 335-1 and EN 60967
EN 61000-6-2	Electromagnetic compatibility (EMC) - Part 6-2: Generic standards - Immunity for industrial environments
EN 61000-6-3	Electromagnetic compatibility (EMC) - Part 6-3: Generic standards - Emission standards for residential, commercial and light-industrial environments

Skinnskatteberg, 30-07-2017

Mats Sándor

Technical Director

2 Disposal and recycling

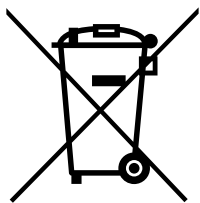

This product is compliant to the WEEE directive. When disposing the unit, follow your local rules and regulations.
This product packing materials are recyclable and can be reused. Do not dispose in household waste.



3 Warnings



Danger

- Make sure that the mains supply to the unit is disconnected before performing any maintenance or electrical work!
- All electrical connections and maintenance work must be carried out by an authorized installer and in accordance with local rules and regulations.



Warning

- This product must only be operated by a person who has suitable knowledge or training within this field or carried out with the supervision of a suitably qualified person.
- Beware of sharp edges during mounting and maintenance. Use protective gloves.



Warning

- All though the mains supply to the unit has been disconnected there is still risk for injury due to rotating parts that have not come to a complete standstill.

Important

- The installation of the unit and complete ventilation system must be performed by an authorized installer and in accordance with local rules and regulations.
- The system should operate continuously, and only be stopped for maintenance/service.
- Do not connect tumble dryers to the ventilation system.
- Duct connections/duct ends must be covered during storage and installation.
- Make sure that filters are mounted before starting the unit.

4 About this document

This installation manual concerns air handling unit type SAVE VTR 300/B manufactured by Systemair. The manual consists of basic information and recommendations concerning the design, installation, start-up and operation, to ensure a proper fail-free operation of the unit.

The key to proper and safe operating of the unit is to read this manual thoroughly, use the unit according to given guidelines and adhere to all safety requirements.

5 Product information

5.1 General

The SAVE VTR 300/B is a heat recovery ventilation unit, with a built in rotating heat exchanger. The SAVE VTR 300/B is suitable for houses with up to 240 m² heated living area.

The SAVE VTR 300/B supplies filtered outdoor air to residential areas and extract air from bathroom, kitchen and wet rooms. SAVE VTR 300/B is equipped with a 1670 W electrical re-heater battery.

5.2 Left and Right models

There are two model options, right (R) and left (L) model. The different models are recognized by the placing of the internal components and the supply air outlet, which is situated on left side of the unit on an (L) unit and on the right hand side on an (R) unit.



Note:

This document describes a left (L) model. The inside of a right (R) model is mirrored.

5.3 Installation recommendation regarding condensation

5.3.1 Condensation inside of the unit

When the unit is installed in a cold attic (close to outdoor temperature) the unit should run continuously. If the unit is intended to be stopped by the user manually or due to calendar function we recommend to install air tight dampers at extract and supply air ducts. The dampers will ensure that no air circulates from the warm parts of the building through the unit to outside (chimney effect). If no dampers are installed there is risk of condensation inside the unit and the outdoor ducts during these stop periods. It also might be that cold air from outside could pass the unit and enter into the building. That could cause condensation outside the supply and extract air ducts and even at the valves in the rooms.

When the unit is not running due to late commissioning in winter time, the supply and extract air ducts should be disconnected and closed due to above mentioned effects until commissioning and regular operation.

5.3.2 Condensation outside of the unit

When the unit is installed in warm humid areas (like laundry) together with low outdoor temperature there is a certain point where moisture can condense outside of the casing. The condensation relation to indoor relative humidity, room and outdoor temperature is shown diagram below. The condensation outside of the unit do not occur in zones bellow each curve.

Important

Recommendation: If condensation occurs, increase ventilation in area close to the unit.

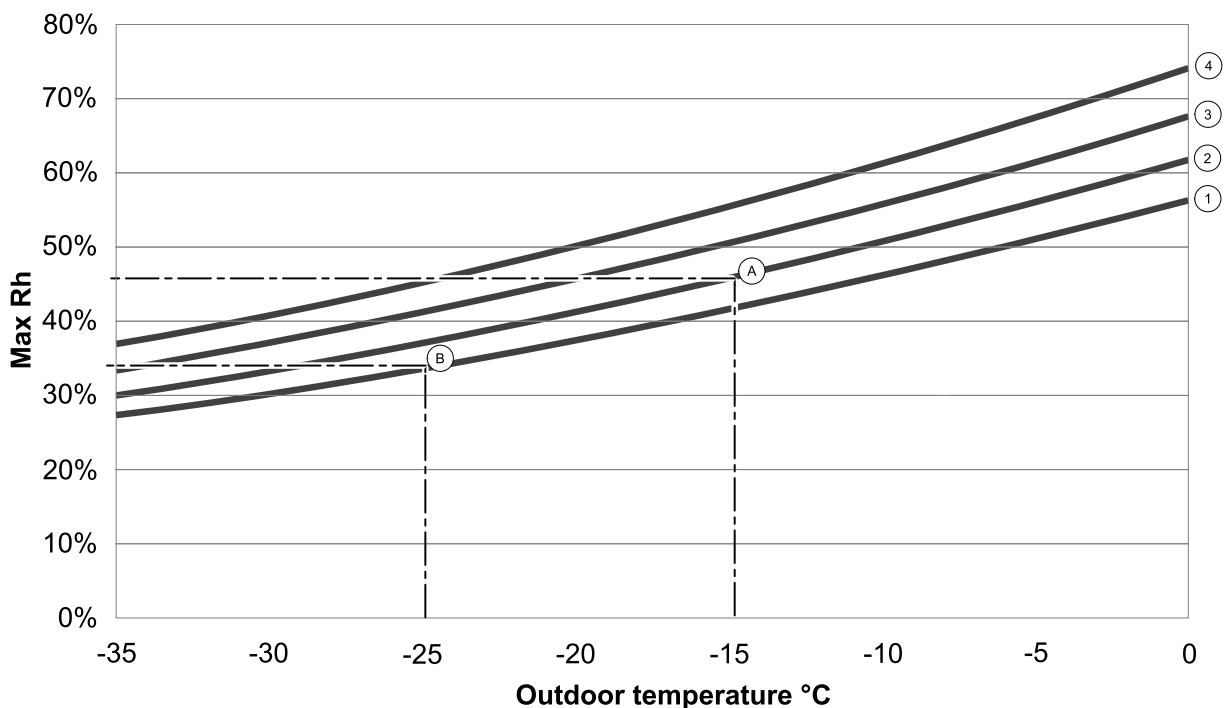

1. Room temperature 20°C

2. Room temperature 22°C

3. Room temperature 24°C

4. Room temperature 26°C

Examples when condensation outside of the unit can occur:

Example A: If the unit is installed in room where temperature is 22°C, outside temperature is -15°C, then dew will start accumulating when relative humidity is 46% and higher.

Example B: If the unit is installed in room where temperature is 20°C, outside temperature is -25°C, then dew will start accumulating when relative humidity is 34% and higher.

5.4 Transport and storage

The SAVE VTR 300/B should be stored and transported in such a way that it is protected against physical damage that can harm panels etc. It should be covered so dust, rain and snow cannot enter and damage the unit and its components.

The appliance is delivered in one piece containing all necessary components, wrapped in plastic on a pallet for easy transportation.

5.5 Technical data

5.5.1 Dimensions and Weight, L model

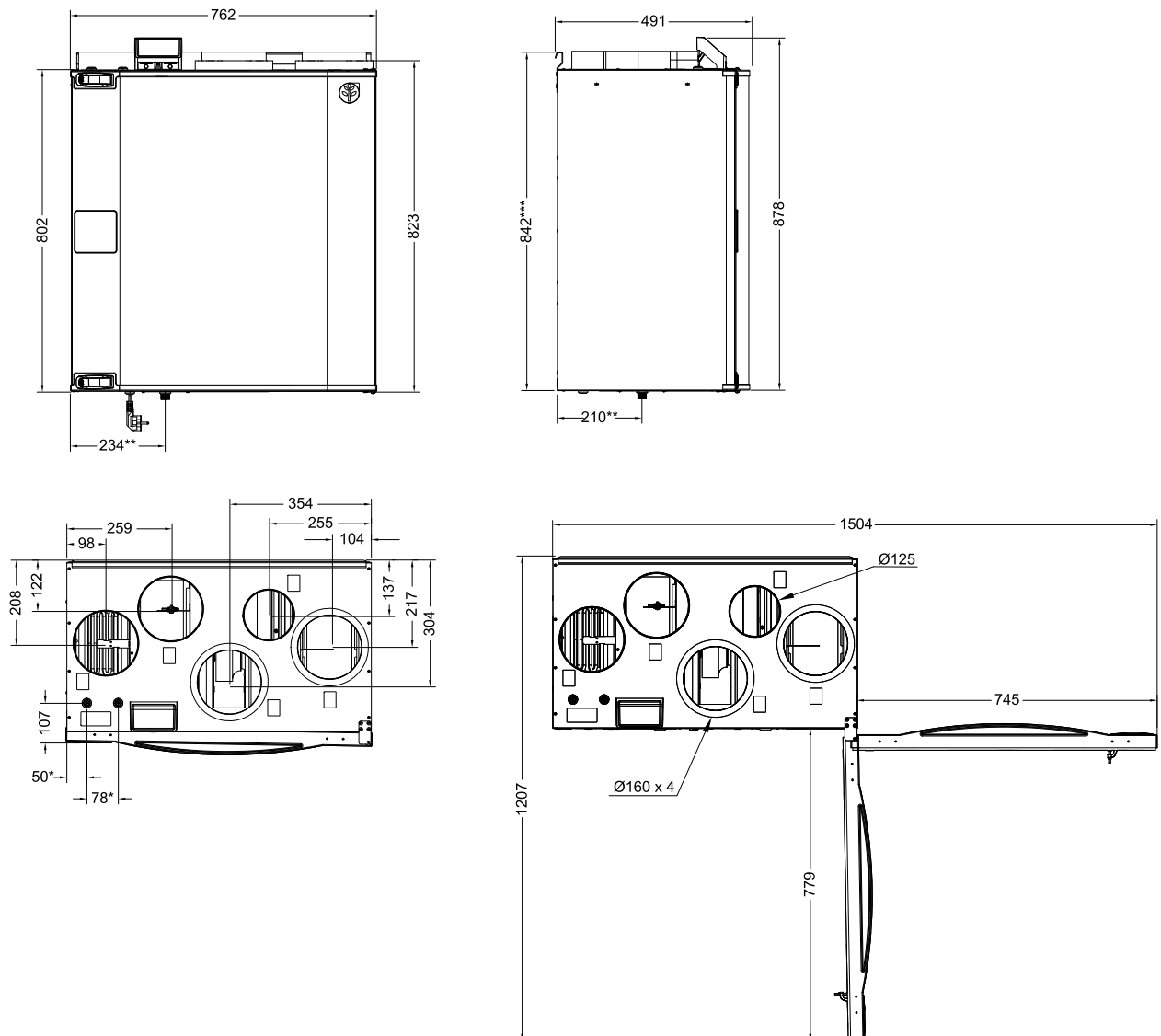

Fig. 1 Dimensions of left hand unit

* Water coil connections.

** Drainage.

*** Height with mounting bracket.

The unit weight is 66 kg.

5.5.2 Dimensions and Weight, R model

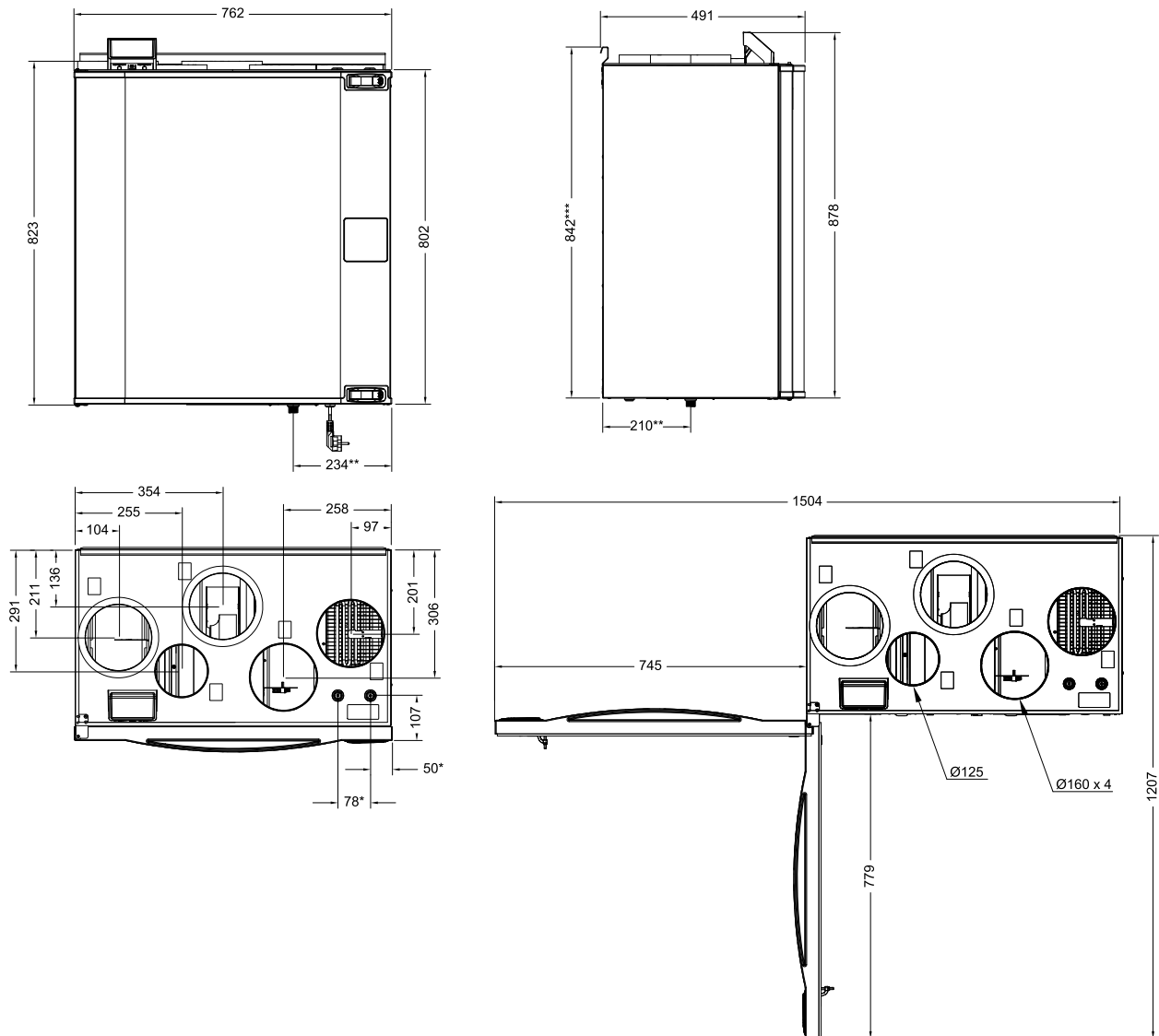

Fig. 2 Dimensions of right hand unit

* Water coil connections.

** Drainage.

*** Height with mounting bracket.

The unit weight is 66 kg.

5.5.3 Duct connections

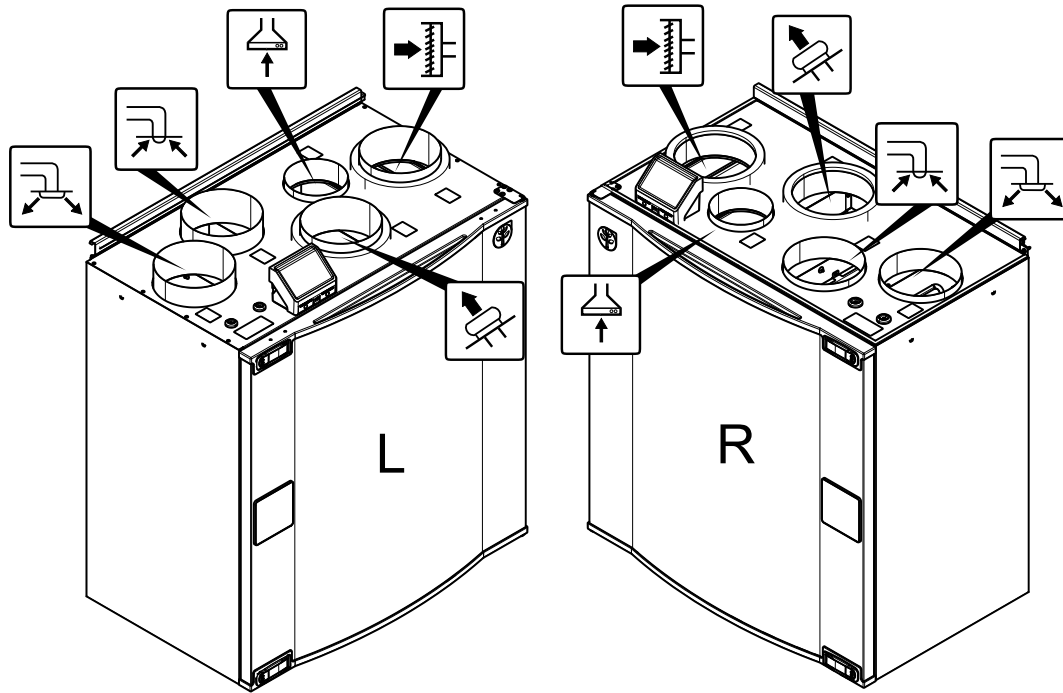

Fig. 3 Duct connections

Position	Description
R	Right hand model (Supply air connection is situated on the right hand side of the unit viewed from the front)
L	Left hand model (Supply air connection panel is situated on the left hand side of the unit viewed from the front)

Symbol	Description	Symbol	Description	Symbol	Description
	Supply air		Outdoor air		Cooker hood air
	Exhaust air		Extract air		

5.5.4 Power consumption and fuse size

Re-heater	1670 W
Fans	176 W
Total power consumption	1846 W
Fuse	10 A

6 Installation

This section describes how to install the unit correctly. To ensure a proper and fail-free operation, it is important that the unit is installed according to these instructions.

6.1 Unpacking

Verify that all ordered equipment are delivered before starting the installation. Any discrepancies from the ordered equipment must be reported to the supplier of Systemair products.

6.2 Where/how to install

The SAVE VTR 300/B should preferably be installed in a separate room (e.g. storeroom, laundry room or similar.).

When choosing the installation position, consideration must be taken that the unit requires regular maintenance. Leave free space for opening of the front hatch in order to perform service and maintenance on components inside the unit.

The SAVE VTR 300/B is supplied with approximately 1 m cable and plug for 230V, single phase earthed connection placed at the bottom of the unit.

Recommended installation location for the outdoor air intake is the northern or eastern side of the building and with a distance to openings for discharge of stale ventilation air, kitchen ventilator, central vacuum system, waste water drainage and other pollution sources like exhaust from traffic etc. Stale discharge air should ideally be led via a roof unit to the outside and with a good distance to any outdoor air intake, windows etc.

6.3 Installation procedure



Note:

It is recommended to remove the heat exchanger before the installation to make the unit lighter. The heat exchanger weighs about 14 kg. How to remove the heat exchanger, see chapter 6.3.1 steps 1 through 3.

1. Prepare the surface where the unit is to be mounted. Make sure that the surface is flat, vertical and that it supports the weight of the unit. Perform the installation in accordance with local rules and regulations.

2. Fit the mounting bracket (1) with the anti-vibration pad (2) to the wall with enclosed screws. Use appropriate holes to screw the bracket firmly to the wall. Bottom side of bracket should be 40 mm (H) below top of unit position.

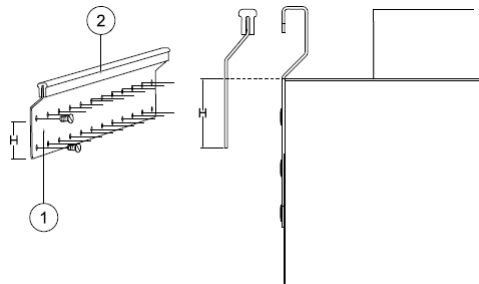

Note:

Make sure that the mounting bracket is completely horizontal once mounted on the wall. Check with a spirit level.

3. Lift the unit in place



Warning

Beware of sharp edges during mounting and maintenance. Use protective gloves. Consider the unit weight when mounting!



Note:

Make sure that the unit is completely vertical and horizontal once mounted on the wall. Check with a spirit level.

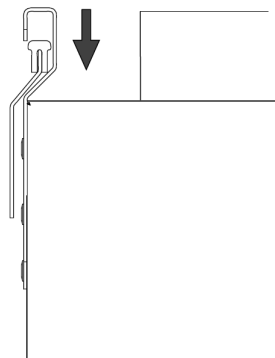

4. Connect the unit to the duct system. Make sure that all necessary accessories are used to create a functional ventilation solution.



Warning

The installation of the unit and complete ventilation system must be performed by an authorized installer and in accordance with local rules and regulations.

5. Remount the heat exchanger if it was removed before the installation. See chapter 6.3.1 steps 4 and 5.

6.3.1 How to remove and remount the heat exchanger

1. Open the front hatch.
2. Disconnect the heat exchanger power supply and the rotor sensor. Both cables are found beside the heat exchanger.

3. Pull out the heat exchanger. Some force may be needed.
4. Remount the heat exchanger. Don't forget to reconnect the heat exchanger power and sensor cables.
5. Close and lock the front hatch.

6.4 Condensation drainage

In general no condensation drainage is needed for rotational heat exchangers at dry conditions. However, if a lot of humid air is present in the residence, a condensation drainage might be needed. Drainage connection is available as an accessory and can be ordered separately. Installation instructions for the drainage are enclosed in the drainage pipes delivery.



Note:

The drainage connection is plugged in the bottom of the unit at delivery. To use the drainage: remove the rubber seal and connect the drainage pipe. Connect the drainage pipe to the sewer. The water can not be led straight to the sewer without a water trap.

7 SAVECair control

7.1 General

SAVECair is a modern touchscreen LCD control panel, simply known as HMI – Human Machine Interface. The touchscreen display provides information about current state of the unit and allows you to control all system functions.

Settings are done by touching the icons or options. The touch screen is sensitive and it is not necessary to press too hard.

7.2 Startup wizard

During the first power up of the unit, you will be asked to set:

- menu language
- time and date
- airflow control type (*Manual/RPM*) and airflow level values
- heater type (*None/Electrical/Water/Change-over*)

If the start-up wizard is cancelled it will start again during next power up of the unit, this will continue until start-up wizard is successfully finished.

7.3 Common symbols

The following selection symbols are common and are present in most menu pages:



Back button to return to a previous menu, located at the upper left corner



Up arrow to increase a value



Down arrow to decrease a value



On and Off slider to activate or deactivate a function. White bubble – function is inactive, green bubble – function is active.

CANCEL

Button to cancel changes

SET/OK

Buttons to confirm changes

Many options show up in a form of the pop-up window. Select the option from the displayed list in the pop-up window and press **OK** to confirm selection.

7.4 Menu overview

- A. Return to home screen
- B. Basic read-only information about the unit
- C. Currently active alarms and alarm history
- D. Configure and check week schedule
- E. Check and change remaining time till filter change
- F. General system preferences
- G. Configuration of all system parameters
- H. Help and troubleshooting menu

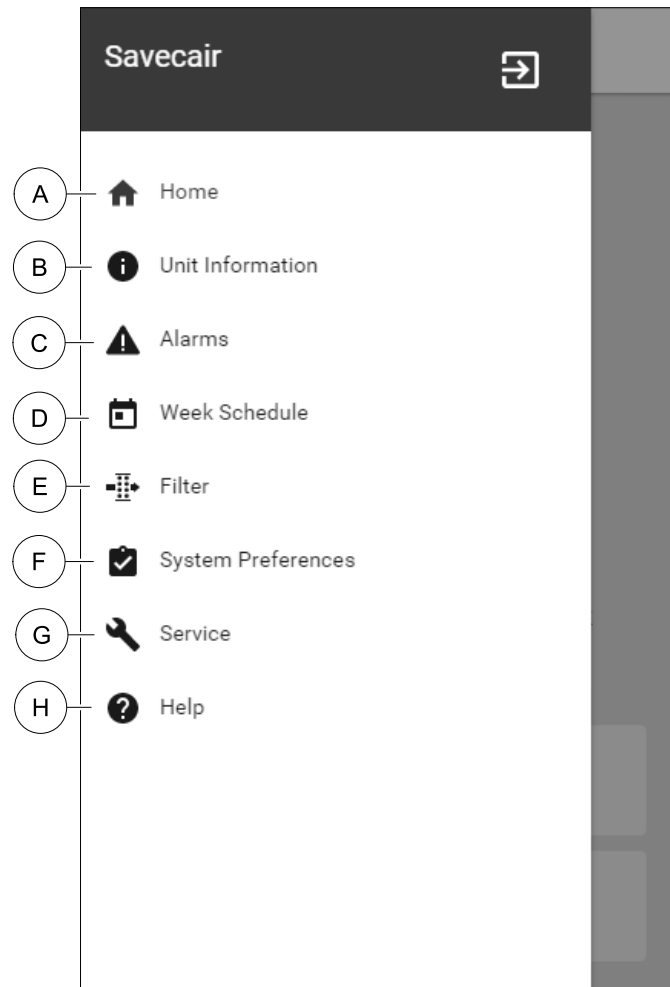

7.5 Home screen

 Touching home icon (pos. A) in drop-down menu list (pos. 1) will always returns you to home screen after commissioning.

1. Drop-down menu list
2. Active user mode
3. Airflow settings
4. Temperature settings
5. List of active alarms
6. Icon list of active user functions

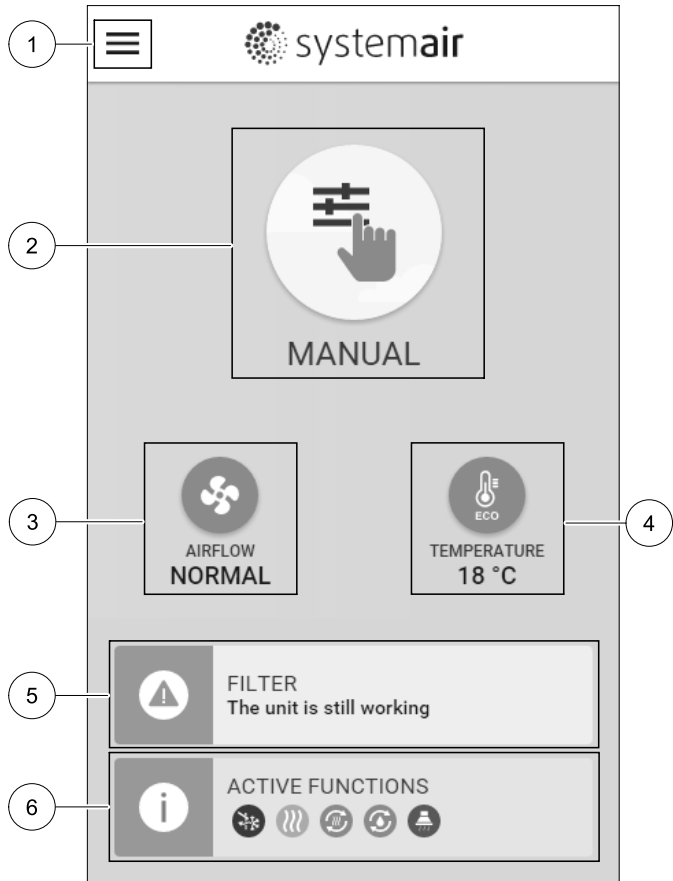

7.5.1 User modes

The first icon at the top of home screen shows currently active user mode. To change the user mode, touch the active user mode icon (pos. 2) and select a new user mode from the list. The unit has 2 permanent and 5 temporary user modes available for selection. Only one mode can be active at a time.

Settings of all modes can be modified in *Service* menu.



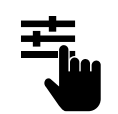

7.5.1.1 Permanent modes

Permanent modes are always active unless interrupted by temporary modes, activated user functions or alarms:

Icon	Text	Description
	AUTO	Automatic airflow control. AUTO mode is available for selection when Demand Control, Week Schedule and/or external fan control functions are configured, otherwise AUTO mode icon won't be visible in active user modes menu. AUTO mode activates Demand Control, Week Schedule and/or external fan control functions. Demand is available to choose as airflow setting in Week Schedule.
	MANUAL	Manual selection of airflow levels. The unit can be set run at one out of four available airflow speeds: <i>Off/Low/Normal/High</i> . Note: The fan can be set to OFF by activating Manual Fan Stop function in <i>Service</i> menu.

7.5.1.2 Temporary modes

Temporary modes are active only for a set period of time unless interrupted by active user modes, activated user functions or alarms:



Icon	Text	Description
	HOLIDAY	Sets speed of both supply and extract air fans to Low levels when user is away from home for a long period of time. ECO mode is active. Delay in days.
	CROWDED	Sets speed of both supply and extract air fans to maximum High levels and temperature setpoint offset to -3 K when apartment is more crowded than usual. Default temperature setpoint offset is -3 K. Delay in hours.
	AWAY	Sets speed of both supply and extract air fans to Low levels when user is away from home for a short period of time. ECO mode is active. Delay in hours.
	REFRESH	Sets speed of both supply and extract air fans to maximum High levels to replace indoor air with a fresh air in a short period of time. Delay in minutes.
	FIREPLACE	Sets speed of supply air fan to High level and extract air fan to Low level to increase air pressure within the apartment for better smoke extraction through the chimney. Delay in minutes.

Settings of all modes can be modified in *Service* menu.

Temporary modes and user functions are active only for a set period of time after which they are terminated and the unit changes back to a former **AUTO** or **MANUAL** mode, depending on which one was active before temporary mode or user function was activated.

7.5.1.3 Digital input functions

Digital input functions always active while digital input is activated.

Icon	Text	Description
	Central Vacuum Cleaner	Function sets speed of supply air fan to High level and extract air fan to Low level to increase air pressure within the apartment for better dust collection through central vacuum cleaner. Function can be activated via digital input – Central Vacuum Cleaner Function .
	Cooker Hood	Sets speed of supply air fan to High level and extract air fan to Low level to increase air pressure within the apartment for better airborne grease and steam collection in the kitchen. Function can be activated via digital input – Cooker Hood Function .

7.5.1.4 Digital input and Mode hierarchy

User modes and functions have a different hierarchy. User functions activated via HMI or mobile APP, such as **AWAY**, **CROWDED**, **FIREPLACE**, **HOLIDAY** and **REFRESH**, are interrupted by manual selection of **AUTO** and **MANUAL** fan modes.

A **FIREPLACE** function has the highest priority between user functions. Other functions activated via HMI/APP can interrupt each other.

If **FIREPLACE** function is hard-wired on the connection board and configured as digital input (DI) then it has a higher priority than **AUTO** and **MANUAL** mode. Digital input for a **FIREPLACE** function has also a higher priority than other hard-wired digital inputs (DI) for: **AWAY**, **CENTRAL VACUUM CLEANER**, **COOKER HOOD**, **CROWDED**, **HOLIDAY** or **REFRESH**.

Digital input and Mode hierarchy:

1. **EXTERNAL STOP**
2. **FIREPLACE** function
3. **COOKER HOOD**, **CENTRAL VACUUM CLEANER**, **CROWDED**, **REFRESH** functions
4. **AWAY**, **CROWDED** functions

7.5.2 Temperature settings



Temperature can be set at SET TEMPERATURE menu accessible from the home screen by touching TEMPERATURE icon with thermometer. Default temperature value is 18°C (range 12–30°C).

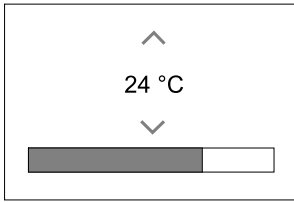

Use up and down arrows or a slider to change the value.

Then touch the SET to confirm changes.

Temperature set point is for room air temperature, supply air temperature or for extract air temperature depending on which control mode is active. Default setting is Supply air temperature control.

Control mode of the temperature can be changed in Service menu.

7.5.2.1 ECO mode



ECO mode is a power saving function that can be activated in SET TEMPERATURE menu.

While ECO mode is active, a temperature setpoint at which heater is activated is lowered to avoid activation of the heater during cold nighttime.

If the temperature is very low and the heater is activated during the nighttime (even with lowered temperature setpoint), then during the upcoming daytime indoor temperature will be increased using the heat exchanger so that accumulated heat could be used during the next cold nighttime, the lowered setpoint for the heater remains.

ECO mode will have impact for the following user functions/modes if selected:	ECO mode is always activated by the following modes:
<ul style="list-style-type: none"> • AUTO mode • MANUAL mode • AWAY mode • HOLIDAY mode • CENTRAL VACUUM CLEANER function • COOKER HOOD function • FIREPLACE mode 	<ul style="list-style-type: none"> • AWAY mode • HOLIDAY mode
	ECO mode is always deactivated by the following user functions/modes:
	<ul style="list-style-type: none"> • CROWDED mode • REFRESH mode • FREE COOLING function

7.5.3 Airflow settings

Airflow settings are available only in MANUAL mode. Click on fan icon on the main screen to enter SET AIRFLOW menu.

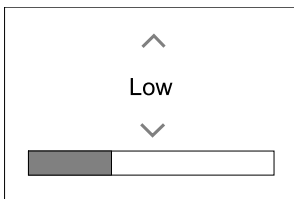

Use up and down arrows or a slider to change the airflow value.

The airflow may be adjusted in these steps: Off/Low/Normal/High. These settings control output signals to the supply and extract fans.

Important

It is **not** recommended to set fan to `OFF` in standard households. If manual fan stop is activated, the unit should be provided with dampers in exhaust and fresh air ducts to avoid cold draught and risk of condensation when the unit has been stopped.
The fan can be set to `OFF` by activating `Manual Fan Stop` function in `Service` menu.

7.5.4 Indoor Air Quality

The unit automatically controls indoor humidity and/or CO₂ levels by adjusting airflow setting. Airflow is increased if air quality is decreasing.

Demand Control function is responsible for IAQ (Indoor Air Quality) regulation. Relative humidity (RH) and/or CO₂ sensors are responsible for IAQ monitoring.

Indoor air quality (IAQ) indicator is available if `AUTO` mode and Demand Control function is activated.

IAQ levels:

- `ECONOMIC`: Actual IAQ value is below low IAQ set point.
- `GOOD`: Actual IAQ value is between low and high IAQ limits.
- `IMPROVING`: Actual IAQ value is above high IAQ set point.

Different airflow settings can be set for `IMPROVING` and `GOOD` IAQ levels in `Service` menu.

Setpoint for relative humidity and CO₂ level can be set in `Service` menu.

7.5.5 Status line

Status line located at the bottom area of home screen displays information about:



List of active alarms. See chapter 7.7.2.3 for more information.







List of active user functions. See chapter 7.6 for more information.

Touching any of these lines will move you to the next page with more detailed list and information about each alarm or active user function.

7.6 Description of User function icons

Icon	Text	Description
	Heating	Connected heater or pre-heater is active and air heating is in process.
	Heat recovery	Heat recovery from apartment is active.
	Cooling	Connected cooler is active and air cooling is in process.
	Cooling recovery	Automatic cooling recovery is active when extract air temperature from apartment is lower than outdoor air temperature and there is a cooling demand (temperature setpoint is lower than outdoor air temperature). No cooling recovery with heating demand. If the outdoor air temperature is higher than the indoor air temperature and there is a heating demand, function <code>Free heating</code> is activated instead.
	Free cooling	Function decreases indoor air temperature by using only cool outdoor air during nighttime to save energy consumption.
	Moisture transfer	Function controls the rotation speed of the heat exchanger to prevent moisture transfer to supply air due to high relative humidity in the extract air. Function is only available for units with <code>Rotating</code> type heat exchanger.

Icon	Text	Description
	Defrosting	Function prevents formation of the ice on the heat exchanger during cold outdoor temperatures.
	Secondary air	Warm air from the living space is used to defrost the heat exchanger using a damper inside the outdoor air duct. The unit switches from outdoor air to secondary air while the extract air fan stops and warm secondary air increases the temperature inside the heat exchanger.
	Vacuum cleaner	Function sets speed of supply air fan to High level and extract air fan to Low level to increase air pressure within the apartment for better dust collection through central vacuum cleaner. Function can be activated via digital input – Central Vacuum Cleaner Function. Always active while digital input is activated.
	Cooker hood	Sets speed of supply air fan to High level and extract air fan to Low level to increase air pressure within the apartment for better airborne grease and steam collection in the kitchen. If a cooker hood with integrated fan is used, then it is recommended to set airflow levels of both fans to Normal. Function can be activated via digital input – Cooker Hood Function. Always active while digital input is activated.
	User lock	Function indicates that the system is locked with a password and cannot be edited or settings changed in any way. System must be unlocked first to make changes.

7.7 Main menu

 User settings and advanced settings

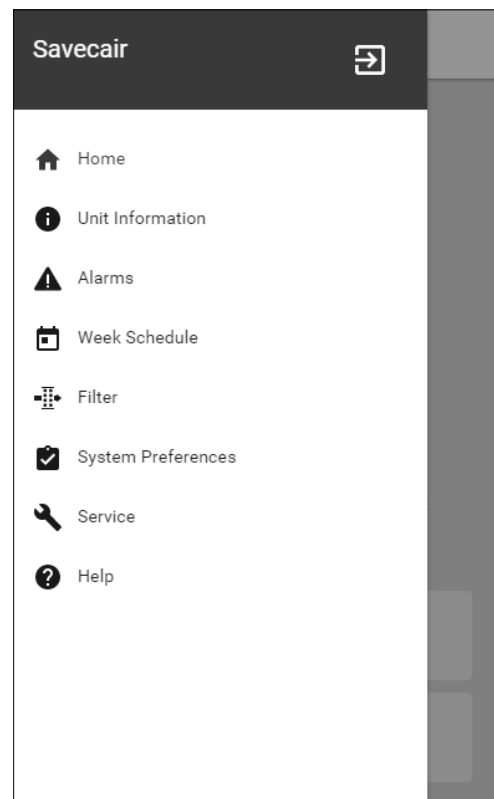

7.7.1 Unit Information



A basic read-only information about status of the unit, configured components and inputs/outputs.

7.7.1.1 Components

Type and settings of heat exchanger, heater, cooler, extra controller.

7.7.1.2 Sensors

Values from sensors and load of fans (rpm).

7.7.1.3 Input Status

Status of configured analog, digital and universal inputs. Connected component type and raw value (volts) is displayed.

7.7.1.4 Output Status

Status of configured analog, digital and universal outputs. Connected component type and value (volts) is displayed.

7.7.1.5 Unit Version

Unit model name, manufacturer number, serial number and unit software versions for Mainboard, HMI and IAM.

7.7.2 Alarms



A detailed information about active system alarms and alarm log of last 20 events.

7.7.2.1 Active Alarms

Alarm screen is empty if there are no active or logged alarms.

Press **HELP** button on the active alarm to access FAQ and troubleshooting (if available). Press **ACKNOWLEDGE** on the individual alarm to clear it. Depending on alarm type and the cause, it might be necessary to do a troubleshooting first to acknowledge active alarm.

It may be not possible to clear the status of alarm if the cause of alarm is still present, as that would immediately trigger alarm to return.

7.7.2.2 Alarms log

Alarm log allows to view last 20 alarms.

Each alarm contains information:

- Alarm name
- Date/time stamp
- Information if the alarm stops the unit or other note

7.7.2.3 Alarm list

Alarm name	Explanation	Do the following
Frost protection	Frost protection of return water in heating coil. <ul style="list-style-type: none"> • Alarm stops the unit and opens the water valve completely. 	The alarm will reset once the water temperature reaches 13°C. Check the water fluid temperature in heating coil. Check the circulation pump of water heater. Contact your installation company or place of purchase.
Frost protection temperature sensor	Indicates malfunction of water heater temperature sensor. <ul style="list-style-type: none"> • Alarm stops the unit. 	Check that frost protection temperature sensor is connected properly and cable is not damaged. Contact your installation company or place of purchase.

Alarm name	Explanation	Do the following
Defrosting error	Indicates failure of pre-heater to preheat the incoming outdoor air (in case Extra controller is configured as Preheater). <ul style="list-style-type: none"> Alarm stops the unit. 	Check the pre-heater reset button. Check the pre-heater cabling. Contact your installation company or place of purchase. Defrosting error may be caused by extremely low outdoor air temperatures or pre-heater failure.
Supply air fan rpm	Rotation speed of the supply air fan is lower than minimum required. Fan malfunction. <ul style="list-style-type: none"> Alarm stops the unit. 	Check quick connectors of the fan. Contact your installation company or place of purchase.
Extract air fan rpm	Rotation speed of the extract air fan is lower than minimum required. Fan malfunction. <ul style="list-style-type: none"> Alarm stops the unit. 	Check quick connectors of the fan. Contact your installation company or place of purchase.
Supply air fan control error	Flow or pressure alarm for supply air. The pressure is bellow pressure limit. <ul style="list-style-type: none"> Alarm stops the unit. 	Check that air tube for pressure sensor is connected properly and cable is not damaged. Contact your installation company or place of purchase.
Extract air fan control error	Flow or pressure alarm for extract air. The pressure is bellow pressure limit. <ul style="list-style-type: none"> Alarm stops the unit. 	Check that air tube for pressure sensor is connected properly and cable is not damaged. Contact your installation company or place of purchase.
Fire alarm	Fire alarm is active. <ul style="list-style-type: none"> Alarm stops the unit. 	Once the external Fire alarm is disabled – alarm has to be acknowledged and unit restarted.
Emergency thermostat	Indicates triggered overheat protection (in case of installed electric re-heater battery).	A triggered manual or automatic overheat protection (EMT) gives an alarm in the control panel. In case a manual overheat protection is triggered, reset it by pushing the reset button. If the automatic overheat protection is triggered, it will reset automatically once the temperature has dropped. If the problem continues contact your installation company or place of purchase.
Bypass damper	Indicates malfunction in bypass damper.	Disconnect the main power supply for 10 seconds to reset control function. Power up the unit, an automatic bypass damper test will be performed. If the alarm occurs again after approximately 2 minutes – contact your installation company or place of purchase.

Alarm name	Explanation	Do the following
Rotor guard	Indicates a rotor malfunction. No rotation guard signal for 180 seconds.	If the rotating heat exchanger has stopped. Check the rotor belt. If the heat exchanger is still rotating, check that the quick connector for the sensor is connected and that there is an air gap of 5-10 mm between the sensor and the magnet. Adjust the gap if necessary. If the alarm persists, the rotor sensor may be faulty. Contact your installation company or place of purchase.
Secondary air damper	Secondary air defrosting failed. Outdoor air temperature sensor measures < 10°C in 2 sec after defrosting OR Outdoor air temperature sensor measures < 5°C in 5 min after defrosting	Check if secondary air damper is in correct position. Check that damper is connected properly and cable is not damaged. Contact your installation company or place of purchase.
Outdoor air temperature sensor	Indicates outdoor air temperature sensor malfunction.	Check that sensor is connected properly and cable is not damaged. Contact your installation company or place of purchase.
Overheat temperature sensor	Indicates overheat temperature sensor malfunction.	Check that sensor is connected properly and cable is not damaged. Contact your installation company or place of purchase.
Supply air temperature sensor	Indicates supply air temperature sensor malfunction.	Check that sensor is connected properly and cable is not damaged. Contact your installation company or place of purchase.
Room air temperature sensor	Indicates room air temperature sensor malfunction.	Check that sensor is connected properly and cable is not damaged. Contact your installation company or place of purchase.
Extract air temperature sensor	Indicates extract air temperature sensor malfunction.	Check that sensor is connected properly and cable is not damaged. Contact your installation company or place of purchase.
Extra controller temperature sensor	Indicates extra controller temperature sensor malfunction.	Check that sensor is connected properly and cable is not damaged. Contact your installation company or place of purchase.
Efficiency temperature sensor	Indicates efficiency temperature sensor malfunction.	Check that sensor is connected properly and cable is not damaged. Contact your installation company or place of purchase.
PDM RH	Indicates internal relative humidity sensor malfunction. Active: measured humidity = 0% Returned: measured humidity > 5%	Check that sensor is connected properly and cable is not damaged. Contact your installation company or place of purchase.
PDM RH Extract air temperature	Indicates internal extract air temperature sensor malfunction. Active: measured temperature = 0°C Returned: measured temperature > 5°C	Check that sensor is connected properly and cable is not damaged. Contact your installation company or place of purchase.

Alarm name	Explanation	Do the following
Filter	Time for filter change.	Change the filter. Change filter according to the instructions in the User Manual. Details about filter retailers can be found in Help menu.
Extra controller alarm	Error from external device.	Check if external device is connected properly and cable is not damaged. Reset overheat protection on electrical pre-heater. Contact your installation company or place of purchase.
External stop	Unit is stopped by external signal.	Operation is stopped by digital signal from external remote device or signal from building management system.
Manual fan stop active	Operation stopped, fans are in manual mode and selected as OFF.	Select another speed of fans (LOW / NORMAL / HIGH) or AUTO mode in HMI home screen.
Overheat temperature	Temperature after reheater is too high. Active: (Overheat temperature sensor measures > 55°C) Returned: (Overheat temperature sensor measures < 50°C)	Alarm is possible if supply airflow is too low when the reheater is switched on. Check the supply airflow. Check that intake grille is not blocked. Check that shut off damper for outdoor air is open in operation. Contact your installation company or place of purchase.
Low supply air temperature	Supply air temperature is too low. Active: (Outdoor air temperature sensor measures < 0°C AND (Supply air temperature sensor measures < 5°C) Returned: (Supply air temperature sensor measures > 10°C)	Check the heat exchanger and re-heater or refer to Point 2 in "Troubleshooting" menu.
CO ₂	External CO ₂ sensor malfunction.	Check that sensor is connected properly and cable is not damaged. In case sensor wireless – check RS485 gateway status and sensor status in HMI. Contact your installation company or place of purchase.
RH	External relative humidity sensor malfunction.	Check that sensor is connected properly and cable is not damaged. In case sensor wireless – check RS485 gateway status and sensor status in HMI. Contact your installation company or place of purchase.
Output in manual mode	One or more of analogue outputs are in manual mode.	Check Service menu for Output settings, and check all configured outputs to be in Auto mode. If any outputs in Manual - change back to Auto mode.

7.7.3 Week Schedule



The unit can be configured to operate at set airflow levels up to two time periods (00:00-23:59) on user selected days.
Week Schedule is active only during AUTO mode.

7.7.3.1 Schedule airflow settings

Touch settings icon to go to SCHEDULE AIRFLOW SETTINGS menu. In this menu set airflow level for scheduled and unscheduled periods. Available levels: Off, Low, Normal, High or Demand. Set temperature setpoint offset for both periods (-10°C - 0°C).



Demand level is available only if Demand Control or External fan function is active.

7.7.3.2 Edit schedule



Touch icon at the bottom left corner of the screen to add a new schedule or press EDIT button to modify already added schedule.

To configure the schedule:

1. Set the time. Touch the START TIME or END TIME values to change time. Use arrow buttons and to increase or decrease value. Confirm with OK button.



Note:

Scheduled time can start but never end at midnight (00:00). The latest END TIME period is 23:59. Scheduled time cannot go to the next day.

If necessary, activate second scheduled period and set up time.

2. Once time is set, click on the day(s) when schedule should be active. It is possible to set a separate schedule for each day.

Already scheduled days are not available for selection for new schedules.

3. Confirm schedule with OK button.

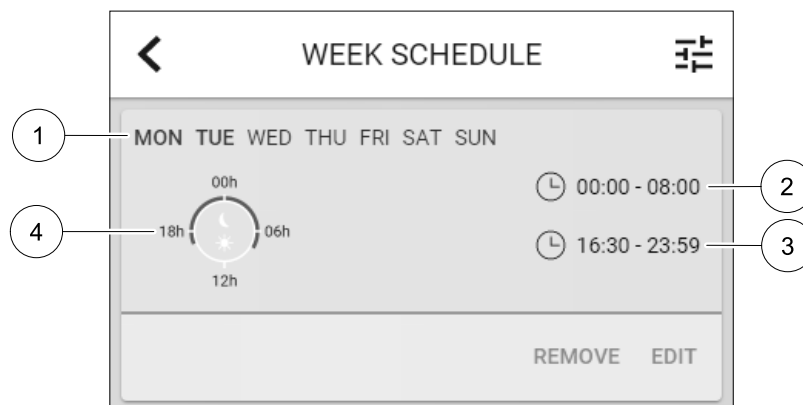
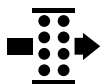

Fig. 4 Week schedule example

Scheduled days are highlighted (pos. 1). First time period (pos. 2) and the second time period (pos. 3) are shown on the right side of each schedule.

Scheduled time period is displayed in blue colour on the clock (pos. 4).

7.7.4 Filter



In this menu the remaining time until filter change is displayed. Editing is locked with a password, use administrator password. See Password Settings in Service menu for more information.

Set duration of the filter until next change for period of 3–15 months in steps of 1 month. Default setting is 12 months.

If a new filter period is selected and confirmed or filter alarm is acknowledged, the timer resets and starts counting from the beginning.

Information what filter type is needed for change or where to order a new filter can be found in Help menu.

7.7.5 System Preferences



Configuration of unit location, language and time.

Change the following information:

- Language (default language is English)
- Country (default country is UK)
- Unit address (address, post code)
- Unit date and time, activate or deactivate summer/winter time switch.

Time will automatically change between summertime and wintertime according to European standard, based on Greenwich time zone and set unit location.

Switch between 12 and 24 hours time format.

- Contact information: contractor, installer, service, phone, website, e-mail, etc.
- Display settings: screen brightness and screen behavior in standby mode.

7.7.6 Service



All unit parameters and settings can be changed in the **Service** menu. The **Service** menu is locked by default and it is necessary to enter a password (default password is 1111).

7.7.6.1 Input



Configuration of inputs

Settings for analog, digital and universal input terminals on the main board, configuration of functionality.

Relative humidity and rotation speed signals from fans are already pre-addressed to specific terminals and cannot be changed, all other inputs are free for configuration by commissioning. Inputs are free to be used for any purpose.

Digital inputs are restricted by signal type and physical number of connections. An input function is only allowed to be used once.

Universal input (UI) configured as universal analog input (UAI) can be configured for several inputs because multiple sensors of the same type can be used. Universal analog inputs (UAI) have only selections for **RH Sensor (RH)**, **CO₂ Sensor (CO₂)**, **Supply Air Fan Control (SAFC)** and **Extract Air Fan Control (EAFC)** wired configurations.

Analog input (AI) temperature sensors are not allowed to be configured more than once.

Already used and configured input signal type is greyed out and not available for selection. However some user functions related to configuration of digital input (**AWAY**, **CROWDED**, **FIREPLACE**, **HOLIDAY** or **REFRESH**) have several possible activation points, via HMI/APP/Wireless/Modbus (BMS).

Digital inputs can be configured to be normally open (**Normally Open (NO)**) or normally closed (**Normally Closed (NC)**). Default setting is **Normally Open (NO)**. Not available for wireless inputs.

PDM (pulse density modulation) input for relative humidity (RH) sensor on the main board is pre-addressed and cannot be changed.

Table 1 Overview of input configuration

Analog inputs	Digital inputs	Universal analog inputs	Universal digital inputs
Input type Value Compensation	Input type Polarity Value	Input type Analog type Value	Input type Digital type Polarity Value

7.7.6.2 Output



Configuration of outputs.

Settings for analog, digital and universal output terminals on the main board and connection board, configuration of functionality.

Fan output PWM (Pulse-width modulation) signal and triac output are already pre-addressed to specific terminals and cannot be changed, all other outputs are free for configuration by commissioning. Outputs are free to be used for any purpose.

Digital outputs are restricted by signal type and physical number of connections.

An output function is only allowed to be used once. Already used and configured terminal is greyed-out in the menu for output type selection.

Analogue and digital outputs have a selection for `Auto/Manual` modes and an adjustable value for `Manual` mode.

`Manual` mode selection overwrites all system related automatic functions. Analogue output adjustable manual value range is 0-10V and digital output values `On/Off`.

Table 2 Overview of output configuration

Analog outputs	Digital outputs
Output type Auto/Manual Value	Output type Auto/Manual Value

7.7.6.3 Components



Configuration of connected components.

Heat Exchanger

- Choose heat exchanger type.
Available types: `Rotating` / `Plate`
- Activate or deactivate passive house function if heat exchanger type `Rotating` is selected.
Options: `Yes` / `No`.
- Choose bypass damper location if heat exchanger type `Plate` is selected. Default setting is based on unit type.
`Supply` / `Extract`
- Set actuator type. Default setting is based on unit type.
Range: `0-10 V` / `2-10 V` / `10-0 V` / `10-2 V`.

Heater

- Choose heater type. Each selection unlocks additional configuration options. Default setting is based on unit type.
Available types: `None` / `Electrical` / `Water` / `Change-over`.
- Set actuator type. Default value is `0-10 V`.
Range: `0-10 V` / `2-10 V` / `10-0 V` / `10-2 V`.
- Set circulation pump temperature. Default setting is `10°C`. This option is available if `Water` / `Change-over` heater type is selected.
Range: `0-20°C`.
- Set circulation pump stop delay. Default setting is 5 minutes. This option is available if `Water` / `Change-over` heater type is selected.
Range: `Off` / `1-60 min`.

Cooler

- Choose cooler type. Each selection unlocks additional configuration options. Default setting is `None`.
Available types: `None` / `Water` / `Change-over`.

- Set outdoor air temperature interlock. Default setting is 10°C.
Range: 0–20°C.
- Set actuator type. Default value is 0–10 V
Range: 0–10 V / 2–10 V / 10–0 V / 10–2 V.
- Set circulation pump stop delay. Default setting is 5 minutes. This option is available if water / Change-over heater type is selected.
Range: off / 1–60 min.

Extra controller

- Choose extra controller type. Each selection unlocks additional configuration options. Default setting is None.
Available types: None / Preheater / Heating / Cooling.
- Set temperature set point of the extra controller. Default value is 0°C.
Range: –30°C – 40°C.
- Set P-band. Default setting is 4°C.
Range: 1–60°C.
- Set I-time. Default setting is off.
Range: off / 1–240 sec.
- Set actuator type. Default value is 0–10 V.
Range: 0–10 V / 2–10 V / 10–0 V / 10–2 V.
- Set circulation pump temperature. Default setting is 0°C. This option is available if Preheater / Heating controller type is selected.
Range: 0–20°C.
- Set circulation pump stop delay. Default setting is 5 minutes.
Range: off / 1–60 min.

7.7.6.4 Control Regulation



Configure how the system is controlled.

Temperature Control

- Configure temperature controller. Choose control mode:
Available modes: Supply air temperature control / Room temperature control / Extract air temperature control
- Choose temperature unit. Default setting is Celsius.
Available units: Celsius / Fahrenheit
- Set P-band. Default setting is 20°C. Set I-time. Default setting is 100 sec.
- Configure SATC split for heater (0–20%), heat exchanger (25–60%) and cooler (65–100%) output settings.
Range: 0–100%.
- Configure cascade control setpoint for min/max supply air temperature, P-band, I-time.
Only available for Room temperature control / Extract air temperature control modes.

ECO mode

- Configure ECO mode settings. Set heater offset. Default setting is 10°C.
Range: 0–10°C.

Fan Control

- Configure airflow and fan settings. Select fan control (airflow) type. Default setting is Manual (%).
Available types: Manual (%) / Manual rpm / Flow (CAV) / Pressure (VAV) / External

Setting	Manual	RPM	Flow (CAV)	Pressure (VAV)	External
Airflow measurement unit.	%	rpm	l/s, m ³ /h, cfm	Pa, inwc	%
P-Band	0-100%	0-3000 rpm	0-500 Pa Default setting: 150 Pa		0-100%
I-time	Off / 1-240 sec.	Off / 1-240 sec. Default setting: 50 sec.	Off / 1-240 sec. Default setting: 50 sec.		Off / 1-240 sec.
Airflow level settings for each level: MAXIMUM LEVEL, HIGH LEVEL, NORMAL LEVEL, LOW LEVEL, MINIMUM LEVEL	16-100%	500-5000 rpm	Sensor range (airflow unit)		0-100%
Manual Fan Stop – turn on or off manual fan stop, this function enables manual fan stop from HMI. Default setting is OFF.					
Pressure Sensors – configure sensor voltage relation to pressure. Set value at which fan alarm occurs. Default setting is None	-	-	Supply air fan control sensor: Pressure at 0V: 0-500 Pa, default setting 0 Pa Pressure at 10V: 0-2500 Pa, default setting 500 Pa. Extract air fan control sensor: Pressure at 0V: 0-500 Pa, default setting 0 Pa. Pressure at 10V: 0-2500 Pa, default setting 500 Pa		-
Set K factor for supply air fan and extract air fan. Default settings are based on unit type.	-	-	SAF K-Factor range: 0-1000 EAF K-Factor range: 0-1000	-	-
Outdoor Compensation	Compensation is always started at fixed value of 0° C. Set stop compensation for outdoor air temperature and compensation value for fan speed. Stop Compensation Temperature range: -25 - 0°C, default setting 0°C Stop Compensation Value range: -50 to 0%, default setting 0%				

Important

Changing the airflow type does not change P-band value automatically. P-band value have to be changed manually after changing the airflow type.

Demand Control

Configure indoor air quality sensors. Once sensor(s) are configured, Demand Control function is activated by choosing AUTO mode in home screen.

- Activate or deactivate CO₂ sensor. Default setting is Off.
Set CO₂ sensor setpoint. Default setting is 800 ppm (parts per million in atmosphere). Normal atmospheric CO₂ concentration is 400 ppm. Range: 100-2000 ppm.
Set P-band, default setting is 200 ppm. Range: 50-2000 ppm.
Set I-Time, default setting is Off. Range: Off/1-120 sec.
- Activate or deactivate RH sensor. Default setting is Off.
Set humidity setpoint in summer, default setting is 60%. Range: 1-100%.
Set humidity setpoint in winter, default setting is 50%. Range: 1-100%.
Set P-band, default setting is 10%. Range: 1-100%.

Set I-time, default setting is `off`, Range: `off`/1-120 sec.

- Select airflow level for `Improving Air Quality`. Range: `Normal` / `High` / `Max`.
- Select airflow level for `Good Air Quality`. Range: `Low` / `Normal`.

RH Transfer Control



Note:

Setting is available if heat exchanger type is set as `Rotating`. It is highly recommended to leave default values for P-band and I-time. They should be changed only by installer and trained staff.

- Activate or deactivate relative humidity transfer functionality. Default setting is `on`.
- If `RH Transfer Control` is activated, configure:
 - Setpoint, default setting is 45% humidity. Range: 1-100% RH.
 - Set P-band, default setting is 4g/kg. Range: 1-100g/kg.
 - Set I-time, default setting is `off`. Range: `off`/1-120 sec.

Defrosting Control



Note:

Setting is available if heat exchanger type is set as `Plate`.

The unit is equipped with an automatic defrost function that is activated when there is risk of icing in the area around the heat exchanger.

- Select defrosting mode. Default setting is `Normal`.

Soft	Dry areas, such as warehouse buildings with few people or industrial buildings that don't use water in their production process.
Normal	Apartments or houses with normal humidity ¹
Hard	Buildings with very high humidity level.

¹ In newly constructed houses it might be necessary with a higher defrost level during the first winter period.

- Set by-pass location. Default setting is based on unit configuration.
`Supply` / `Extract`.
- Set preheater setting. Default setting is based on unit configuration.
`Auto` / `Fixed`
`Fixed` pre-heater setting allows user to adjust pre-heater setpoint manually. `Auto` pre-heater setting sets floating pre-heater activation setpoint (Stop defrosting temperature +2K).
- Set if secondary air is allowed. Default setting is `off`.
`off` / `on`.

Cooling Control

- If the outdoor air is warmer than the extract air and the supply air is above the setpoint, cooling recovery occurs. This condition blocks the heat regulation process. Activate or deactivate cooling recovery. Default setting is `on`.
Set cooling limit. Cooling recovery is allowed if extract air temperature is lower than outdoor air temperature by a set limit (default setting is 2K) and cooling demand is present.
- Configure status, temperature and duration of free cooling. Activate or deactivate free cooling. Default setting is `off`.
Set supply and extract air fan levels during free cooling. Default setting is `Normal`. Range: `Normal` / `High` / `Maximum`.
Set start condition. Outdoor daytime temperature for activation, default setting is 22°C. Range: 12-30°C.
Stat stop conditions. Extract/Room temperature, default setting is 18°C. Outdoor high temperature limit, default setting is 23°C. Outdoor low temperature limit is 12°C. Start and stop time.

7.7.6.4.1 Finding RPM for desired airflow

It is necessary to set fan RPM (revolutions per minute) for each airflow level to control airflow by changing fan speed. Fan speed differ for each household because of different unit size, duct system and system pressure. In order to find correct fan speed, external tool must be used at Systemair website.

1. Go to Systemair website and find your unit.
2. Go to Diagram tab and type in desired airflow values in l/s, m³/h, m³/s or cfm for supply and extract air. Input pressure drop in duct system (if this value is not know, type in 100 Pa for both supply and extract air)

Air flow	Air flow (Supply)	<input type="text" value="60"/>	<input type="text" value="m³/h"/>
	Air flow (Extract)	<input type="text" value="60"/>	
Pressure drop duct system	External pressure (Supply)	<input type="text" value="100"/>	<input type="text" value="Pa"/>
	External pressure (Extract)	<input type="text" value="100"/>	

Fig. 5 Example of airflow and external pressure selection

3. See calculated speed values in revolutions per minute (rpm) for both supply and extract air in the table bellow diagrams.

Power	14,0	13,3 W
Speed	<input type="text" value="1751"/>	<input type="text" value="1640"/>
SEP (clean filters)	1.67	W/(m³/s)

Fig. 6 Example speed for supply and extract air

4. Use this procedure to find fan speed for all airflow levels: MINIMUM LEVEL, LOW LEVEL, NORMAL LEVEL, HIGH LEVEL, MAXIMUM LEVEL.
5. Finally in the control panel go to Service menu, enter the password, then go to Control Regulation → Fan Control. Choose RPM as airflow type and in sub-menu Airflow Level Settings enter calculated fan speed values for each level.

7.7.6.5 User Modes



Set airflow level, duration and offset for each user mode.

Set supply and extract air fan levels, default duration and temperature offset where available for user modes:

- Away
- Central Vacuum Cleaner
- Cooker Hood
- Crowded
- Fireplace
- Holiday
- Refresh

7.7.6.6 Communication



Configure Modbus and wireless settings

Modbus

- Set Modbus address. Default setting is 1.
- Set baud rate. Default setting is 19200.
- Set parity. Default setting is None. Range: None / Even / Odd.
- Set stop bits. Default setting is 2. Range: 1-2.
- Shows Smartly-Gateway state.

HMI

- Shows communication information for HMI. Modbus device number (1-10) and Modbus termination: Active/Inactive.



7.7.6.7 Logs

Information about alarms, fans and parameters are stored in `Logs` menu.

Fans Levels

- Time counter for each supply air fan level duration is displayed. Counted and total time. Reset counted time.
 - Level 1: 0%
 - Level 2: 1-29%
 - Level 3: 30-44%
 - Level 4: 45-59%
 - Level 5: 60-100%

Parameters

- Select parameter type and create a graph based on stored data . Export parameters data by touching arrow button . (only available in mobile application)

7.7.6.8 Unit Backups

In this menu it is possible to save and restore user and factory settings.

User backups

- Touch `SAVE` button to save current configuration and parameters.
 - Touch `RESTORE` button to restore last saved user configuration and parameters

Factory settings

- Touch `RESTORE` button to restore factory configuration and parameters. This will also overwrite changed password.

Software versions

Displays current version of main circuit board, Internet Access Module and HMI.

- Touch `SOFTWARE UPDATE` button to update software if there is a newer version.

7.7.6.9 Password Settings

Service level is always locked with a password. Other menu levels have a separate option for locking. If password requirement is activated for different menu levels, these are unlocked with the administrator password.

Choose what menus should be locked or not.

7.7.7 Help

FAQ, troubleshooting of alarms, contact information for support is provided in this menu.

- `Service partner` – information about service partner.
 - `Company`
 - `Telephone`
 - `Homepage`
 - `Email`
- `User modes` – detailed description of all user modes.
- `Functions` – detailed description of different user functions.

- **Alarms**— detailed description of all alarms.
- **Troubleshooting**— information about all different possible malfunctions.

8 Electrical connections

The SAVE VTR 300/B is wired internally from factory.

The electrical connection box can be found on the supply air outlet side of the unit behind a cover plate. The print card (1) can easily be taken out from the unit.

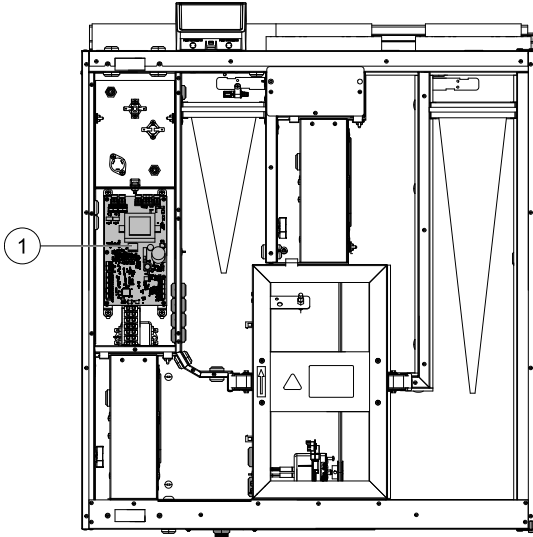

Fig. 7 Print card position

8.1 Main board layout

The SAVE VTR 300/B is equipped with built-in regulation and internal wiring.

The figure shows the main circuit board. See wiring diagram for more information.

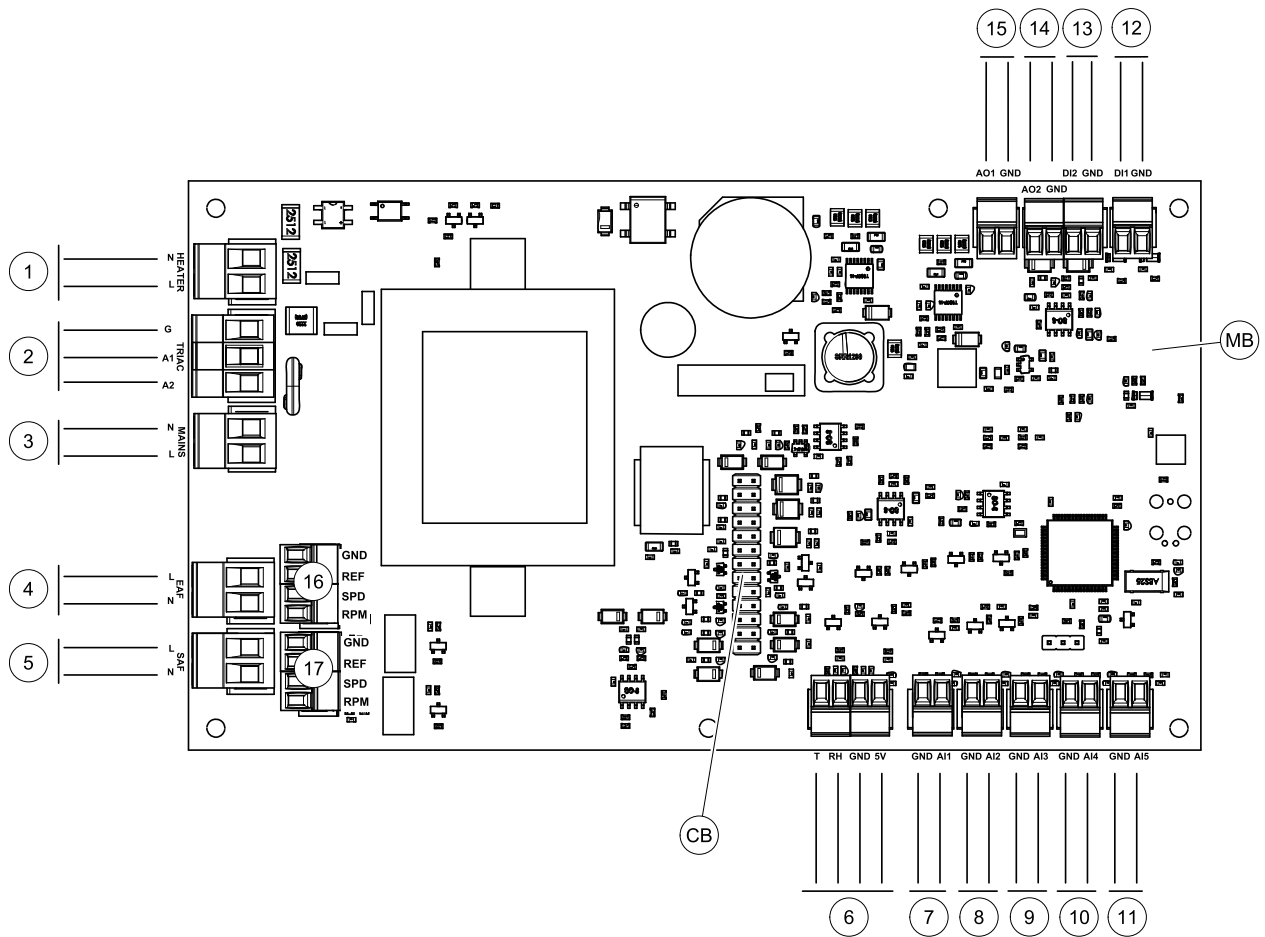

Fig. 8 Main circuit board connections

Position	Description
MB	Main circuit board
CB	Connection to the external connection box
1	Terminals for a heater
2	Terminals for a TRIAC
3	Terminals for the mains power supply
4	Terminals for power supply of extract air fan
5	Terminals for power supply of supply air fan
6	Terminals for internal relative humidity/temperature sensor
7	Analog input 1 – Outdoor air sensor
8	Analog input 2 – Supply air sensor
9	Analog input 3 – Freely configurable
10	Analog input 4 – Freely configurable / Overheat temperature sensor (units with heater)
11	Analog input 5 – Freely configurable
12	Digital input 1 – Rotor guard sensor (VSR, VTR units)/ Damper signal (VTC units)
13	Digital input 2 – Freely configurable / Cooker hood (VTR 150/K unit)
14	Analog output 2 – Freely configurable / Electrical heater controller (VTC 700 unit)
15	Analog output 1 – Rotor of the heat exchanger (VSR, VTR units) / Damper control (VTC units)
16	Terminals for speed control of extract air fan
17	Terminals for speed control of supply air fan

8.2 External connections (Connection board)

External connections to the main circuit board are done via connection board situated outside of the unit.

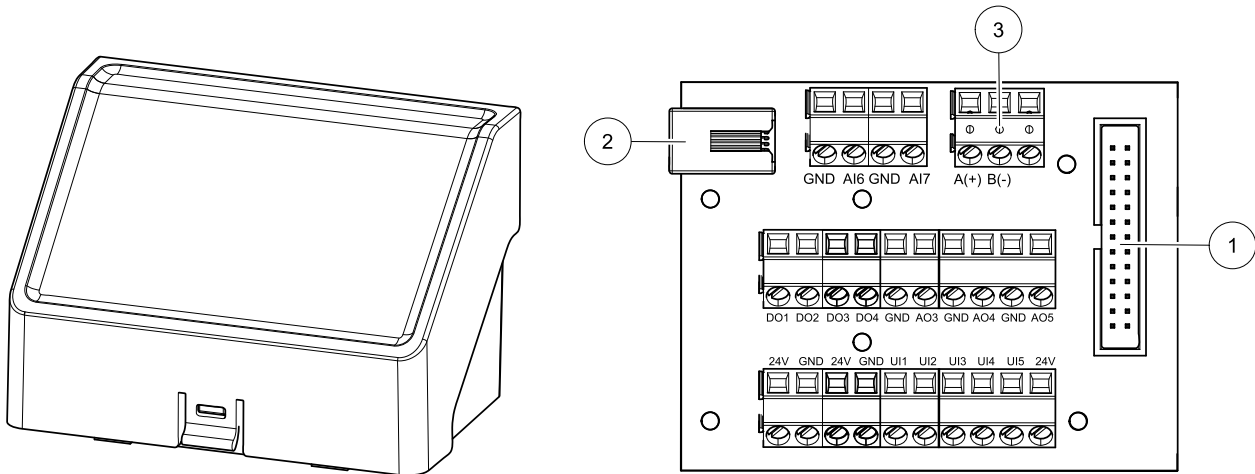

Fig. 9 External connection box and board

Position	Description
1	Connection to the main circuit board
2	Connection for external control panel (HMI) or Internet access module (IAM)
3	Modbus RS485 connection
AI6-7	Freely configurable Analog input. None/Input type selection in HMI.
DO1-4	Freely configurable Digital output. None/Output type selection in HMI.
AO3-5	Freely configurable Analog output. None/Output type selection in HMI. Actuator type 0-10V, 10-0V, 2-10V, 10-2V.
UI1-5	Freely configurable Universal input. Can be configured to act as Analogue input (0-10V) or as Digital input (24V). None/Input type selection in HMI (NC or NO polarity).
24V	Maximum current 200mA at 24VDC +/-10%.

9 Before starting the system

When the installation is finished, check that:

- The unit is installed in accordance with the instructions
- The unit is correctly wired
- Outdoor and exhaust air dampers and silencers are installed and that the duct system is correctly connected to the unit
- All ducts are sufficiently insulated and installed according to local rules and regulations
- Outdoor air intake is positioned with sufficient distance to pollution sources (kitchen ventilator exhaust, central vacuum system exhaust or similar)
- All external equipment are connected
- The unit is correctly configured and commissioned
- The week schedule and airflow settings are correctly programmed.

10 Service

10.1 Warnings



Danger

- Make sure that the mains supply to the unit is disconnected before performing any maintenance or electrical work!
- All electrical connections and maintenance work must be carried out by an authorized installer and in accordance with local rules and regulations.



Warning

- This product must only be operated by a person who has suitable knowledge or training within this field or carried out with the supervision of a suitably qualified person.
- Beware of sharp edges during mounting and maintenance. Use protective gloves.



Warning

- All though the mains supply to the unit has been disconnected there is still risk for injury due to rotating parts that have not come to a complete standstill.

Important

- The installation of the unit and complete ventilation system must be performed by an authorized installer and in accordance with local rules and regulations.
- The system should operate continuously, and only be stopped for maintenance/service.
- Do not connect tumble dryers to the ventilation system.
- Duct connections/duct ends must be covered during storage and installation.
- Make sure that filters are mounted before starting the unit.

10.2 Internal components

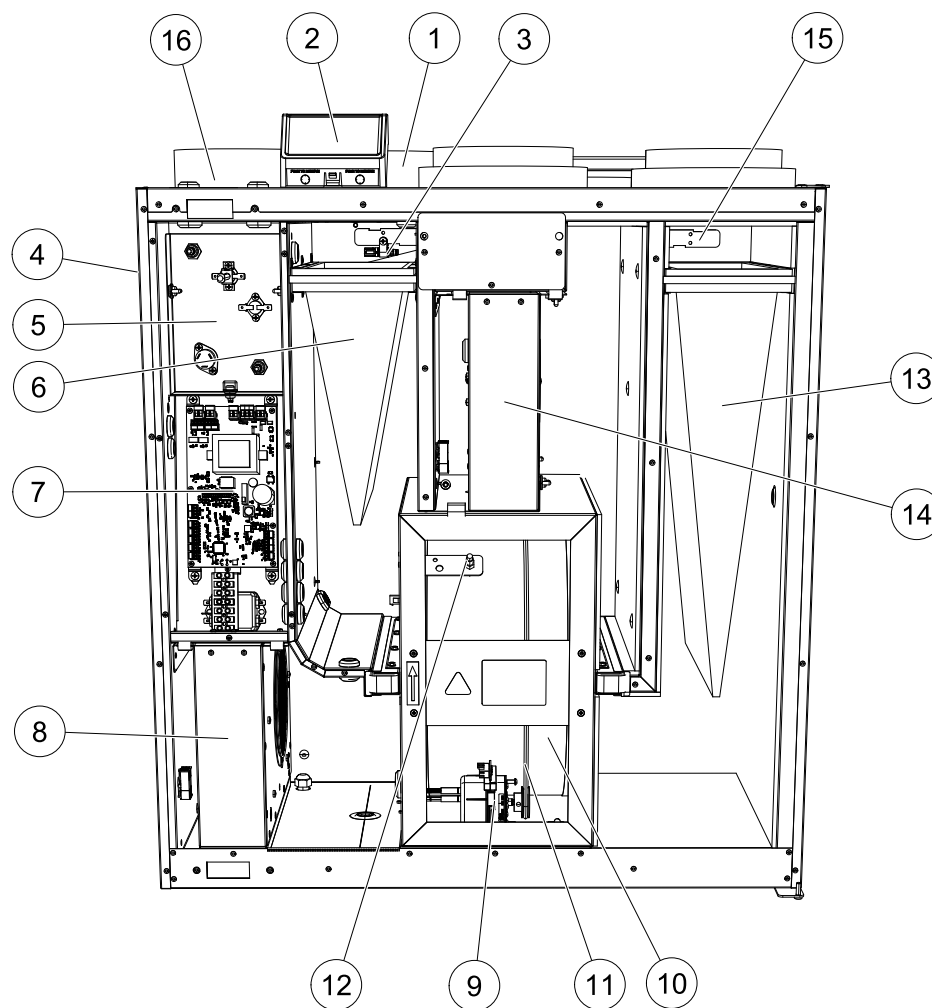

Fig. 10 Internal components

Position	Description
1	Mounting bracket
2	External connections
3	Relative humidity/Extract air temperature sensor
4	Overheat protection sensor
5	Internal electrical re-heater
6	Extract air filter
7	Main print card
8	Supply air fan
9	Rotor motor and belt pulley
10	Rotating heat exchanger
11	Heat exchanger drive belt
12	Rotor sensor
13	Supply air filter
14	Extract air fan
15	Outdoor air sensor
16	Supply air sensor

10.2.1 Component descriptions

10.2.1.1 Fans

The fans have external rotor motors of EC type which can be steplessly controlled individually 16–100%. The motor bearings are life time lubricated and maintenance free. It is possible to remove the fans for cleaning, see “User Manual” for more information.

10.2.1.2 Filters

The factory installed filters are of filter quality F7 for the supply air and G3 for the extract air filter. The filters need to be replaced when polluted. New sets of filters can be acquired from your installer or wholesaler.

Filter quality G3 can be installed for supply air filtering.
The filter type is labelled on the top of the filter

10.2.1.3 Heat exchanger

SAVE VTR 300/B is equipped with a rotating heat exchanger. Required supply air temperature is therefore normally maintained without adding additional heat.

The heat exchanger is removable for cleaning and maintenance, see “User Manual” for more information.

10.2.1.4 Main circuit board

The main circuit board controls all functions and the unit.

It is possible to connect external accessories to a free terminals on the main circuit board.

10.2.1.5 Connection box

Connection box is placed outside of the unit. It contains connection board. All external accessories can be connected to the unit via connection board with freely configurable terminals.

10.2.1.6 Temperature sensors

Four temperature sensors (NTC, 10 kΩ at 25°C) are included in the unit from factory and positioned in the corresponding air chambers.

The sensors are connected to the main print card. See wiring diagram for more information.

10.2.1.7 Humidity sensor

Relative humidity sensor (RH) is included in the unit at factory and positioned in the extract air chamber.

The sensor is connected to the main circuit board. See wiring diagram for more information.

10.2.1.8 Electrical Re-heater battery

The re-heater battery is positioned in the supply air chamber.

The re-heater is activated by a relay and switches on if the supply air temperature is lower than the set point and switches off if one or more of the following conditions are met:

1. If the supply air temperature is above the set point.
2. If the over heat protection is activated or the sensor is malfunctioning.
3. If the emergency thermostat is triggered or broken.
4. If the supply air sensor is in error state.
5. If the supply air fan is not running.
6. If the heater is set to disabled in the menu.

10.2.1.9 Overheat protection reset button

If the supply air temperature is low, it can indicate that the over heat protection is triggered. The overheat protection can be reset by pressing the reset button (1).

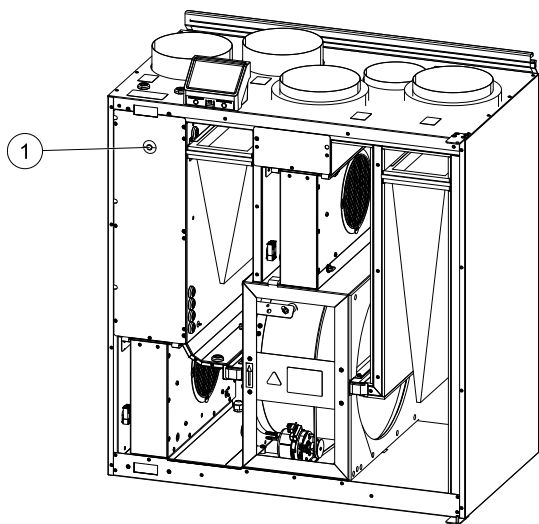

Fig. 11 Overheat protection reset button

10.3 Replacing rotor drive belt



Note:

Depending on model, left or right, it may be necessary to remove the heat exchanger in order to replace a broken drive belt since the belt pulley cannot be accessed. If the rotor motor is placed at the back of the unit, it is recommended to remove the heat exchanger to change the drive belt, see chapter 10.3.2.

If the alarm Rotor guard is raised, see chapter 7.7.2.3, the rotor drive belt may be damaged or broken.

The replacement drive belt (1) is adjustable and delivered with a nipple attached in one end.



Danger

- Make sure that the Mains supply to the unit is disconnected before performing any maintenance or electrical work!



Warning

Risk of personal injury! The heat exchanger weighs about 14 kg. There is a risk that the heat exchanger falls out of the unit. Make sure that small children are not beneath the unit when the heat exchanger is removed!

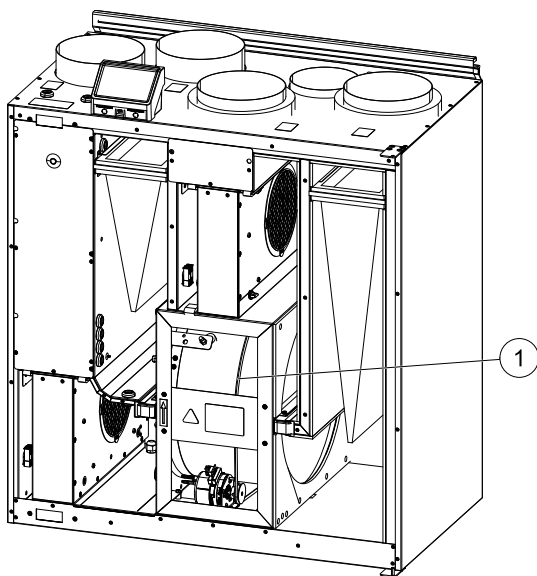

Fig. 12 Rotor drive belt

10.3.1 Heat exchanger mounted

1. Stop the unit by disconnecting the mains.
2. Open the front hatch.
3. Remove the broken drive belt.
4. Use tape to attach the drive belt to the rotating heat exchanger, and rotate the exchanger by hand to get hold of the drive belt.
5. Remove the tape and put the "empty" end on to the nipple.
6. Press the drive-belt ends firmly towards each other to secure the nipple.
7. Pull the drive belt on to the belt pulley and rotate the exchanger by hand. Check that the belt pulley rotates.



Note:

If the drive belt slips, the drive belt may be too long and needs to be shortened. Cut the drive belt 5 mm and go to step 6.

8. Close and lock the front hatch and connect the unit to mains.
9. Check that the alarm has ceased on the Control Display.



Note:

If the alarm remains, check the rotor sensor.

10.3.2 Heat exchanger removed

1. Stop the unit by disconnecting the mains.
2. Open the front hatch.
3. Disconnect the heat exchanger power supply and the rotor sensor. The cables are found beside the heat exchanger at the back.
4. Pull out the heat exchanger towards you. Some force may be needed.
5. Remove the broken drive belt.
6. Apply the new drive belt around the heat exchanger.
7. Press the drive-belt ends firmly towards each other to secure the nipple.
8. Pull the drive belt on to the belt pulley and rotate the exchanger by hand. Check that the belt pulley rotates.



Note:

If the drive belt slips, the drive belt may be too long and needs to be shortened. Cut the drive belt 5 mm and go to step 7.

9. Mount the heat exchanger. Don't forget to reconnect the rotor power and sensor cables.
10. Close the front hatch and connect the unit to mains.
11. Check that the alarm has ceased on the Control Display.



Note:

If the alarm remains, check the rotor sensor.

10.4 Troubleshooting

If problems should occur, please check the items below before calling your service representative.

Malfunction	Action
Fans do not start	<ol style="list-style-type: none"> 1. Check the HMI for alarms. 2. Check that all fuses and fast couplings are connected (main power supply and fast couplings for supply and extract air fans). 3. Check that the week schedule is ON and running in AUTO mode. The week schedule might be in OFF mode with the air flow set to OFF (chapter 7.7.3).
Reduced airflow	<ol style="list-style-type: none"> 1. Check the HMI for alarms. Some alarms can reduce the airflow to LOW if active. 2. The unit could be in defrost mode. This reduces the fan speed and in some cases shuts down the supply air fan completely during the defrosting cycle. The fans go back to normal after finished defrosting. There should be a defrosting function icon visible in the APP or HMI home screen if defrosting is active. 3. If the outdoor air temperature is below 0°C (Outdoor air temperature sensor (OAT) measures < 0°C) outdoor airflow compensation function can be active (if enabled). Fan speed (Supply or Supply/Extract air fans) is linearly reduced for decreasing outdoor air temperature. 4. Check if temporary user mode that reduces airflow is not activated, for example AWAY, HOLIDAY, etc. Also check digital inputs CENTRAL VACUUM CLEANER and COOKER HOOD. 5. Check setting of airflow in the HMI. 6. Check week schedule settings (chapter 7.7.3). 7. Check filters. Is change of filters required? 8. Check diffusers/louvres. Is cleaning of diffusers/louvres required? 9. Check fans and heat exchange block. Is cleaning required? 10. Check if the buildings air intake and roof unit (exhaust) have been clogged. 11. Check visible duct runs for damage and/or build up of dust/pollution. 12. Check diffuser/louvre openings.
The unit cannot be controlled (control functions are stuck)	<ol style="list-style-type: none"> 1. Reset control functions by pulling out the plug for 10 seconds. 2. Check the modular contact connection between the HMI and the main printed circuit board.
Low supply air temperature	<ol style="list-style-type: none"> 1. Check the display for alarms. 2. Check the active user functions in HMI screen if Defrosting function is running. 3. Check set supply air temperature in the HMI. 4. Check if ECO mode is activated in HMI (it is a power saving function and prevents the heater from activating). 5. Check if user modes HOLIDAY, AWAY or CROWDED are activated in the HMI or via a hardwired switch. 6. Check the analogue inputs in the service menu to verify that the temperature sensors are functioning correctly. 7. In case of installed electrical/other re-heater battery: Check if the overheat protection thermostat is still active. If necessary, reset by pressing the red button on the front plate of the electrical re-heater. 8. Check if the extract filter must be changed. 9. Check if the unit has a re-heater battery connected. At very cold outdoor conditions an electrical or water heating battery might be necessary. A re-heater battery can be acquired as an accessory.
Noise/vibrations	<ol style="list-style-type: none"> 1. Clean fan impellers. 2. Check that the screws holding the fans are tightened. 3. Check that the anti vibration lists are fitted to the mounting bracket and to the back of the unit. 4. Check that the rotor belt is not slipping if the unit has rotating heat exchanger.

11 Accessories

SAVE VTR 300/B have many available accessories that can be used to expand functionality of the unit and increase comfort level.

Recommended accessories can be always found at Systemair website www.systemair.com by searching the article number or the name of the desired accessory.

11.1 Internet Access Module (IAM)

Internet access module is a device that allows to connect to the unit and control it via a mobile application or directly from the computer and receive automatic updates.

The Cloud is a mediator between the user and the unit. To access your unit via Cloud, it has to be connected to the internet via Internet Access Module.



The Internet Access Module (IAM) should be connected to the Connection Board (CB) and then via WiFi or Ethernet cable to the internet gateway (router).

For more information read the manual that comes with the accessory.

Component/product – Article number:

- Internet Access Module (IAM) – 211243

11.1.1 Mobile application and Login

A mobile application to access your unit via internet can be downloaded from Google Play or AppStore.

Once application is installed on your smartphone and IAM is connected properly:

1. Launch the application. In the login screen (pos. 1) enter your unique UNIT ID number which can be found on the back label of IAM.
2. Press LOG IN button (pos. 2).
3. When you connect to your IAM for the first time, you must set your own unique password. In the next menu screen enter your new password and press CHANGE PASSWORD (pos. 3).
4. Confirm change by pressing IAM activation button for 2–3 seconds.
5. You can now login with your new password.

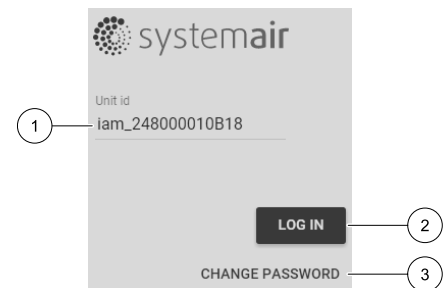

11.2 Indoor air quality sensors



Indoor air quality sensors (IAQ) are CO₂, relative humidity and temperature transmitters that must be installed either in extract air duct or the room depending on the type of transmitter.

- IAQ – indoor air quality sensor (CO₂, RH and temperature)
- CO₂ – CO₂ duct sensor
- 1 – Outdoor air
- 2 – Supply air
- 3 – Extract air
- 4 – Exhaust air

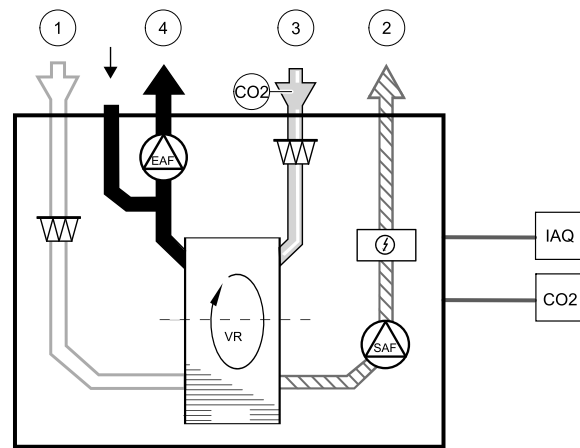

Component/product – Article number:

- Systemair-1 CO₂ duct sensor – 14906
- Systemair-E CO₂ sensor – 14904
- Room sensor 0-50C (temperature) – 211525
- Systemair-E CO₂ RH Temperature – 211522

Installation and connection

1. Install IAQ sensor in the duct or the room depending on the transmitter type.
2. Connect CO₂ sensor to any free universal analog input (UI) on the connection board.
3. If IAQ sensor contains relative humidity transmitter:
Connect it to any free universal analog input (UI) on the connection board.
4. If IAQ sensor contains room temperature transmitter:
Connect it to any free analog input (AI) on the connection board (only AI6 and AI7 are available on the connection board).

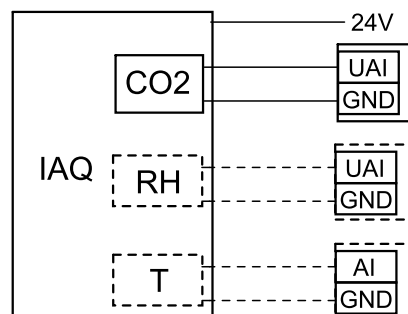

Fig. 13 IAQ connections

Configuration

1. Go to *Service* menu.
2. Enter password (default 1111).
3. Configure of CO₂ and/or relative humidity sensor: Go to *Input* menu. Select *UNIVERSAL* tab. Select the universal input to which the sensor is connected. Example if it is connected to UI4 on the connection board, then select *UNIVERSAL INPUT 4*. Select signal type as *Analog input* and select sensor type from the input type list: *RH sensor (RH)* and/or *CO₂ Sensor (CO₂)*.
4. Configure room temperature sensor: Go to *Input* menu. Select *ANALOG* tab. Select the analog input to which the sensor is connected. Example if it is connected to AI6 on the connection board, then select *ANALOG INPUT 6*. Select input type as *Room Air Temperature Sensor (RAT)*.

11.3 Temperature control

11.3.1 Electrical duct pre-heater



Electrical pre-heater can be installed in the outdoor air duct to pre-heat outdoor air before it reaches the unit and prevent icing in the heat exchanger.

- PH – electrical pre-heater
- ECT – extra controller temperature sensor
- H – contactor
- 1 – Outdoor air
- 2 – Supply air
- 3 – Extract air
- 4 – Exhaust air

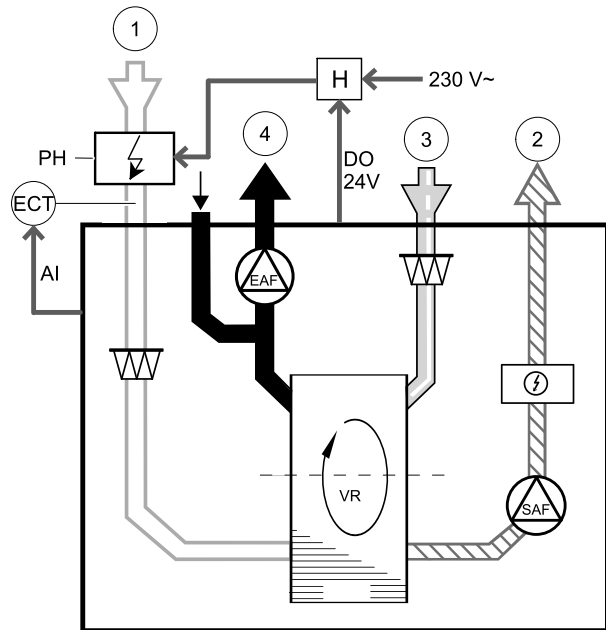

Component/product – Article number:

- CB 160-1,2 230V/1 Duct heater – 5291
- Duct temperature sensor (ECT) – 211524
- Contactor B6 30-10 220-240V 40 – 201519

Installation and connection

1. Install electrical pre-heater at least 100 mm distance from the unit in the outdoor air duct. Contactor is used to control the pre-heater. Connect contactor it to any free digital output.
2. Connect pre-heater and the power supply to the contactor.
3. Connect extra controller temperature sensor (ECT) to any free analog input.

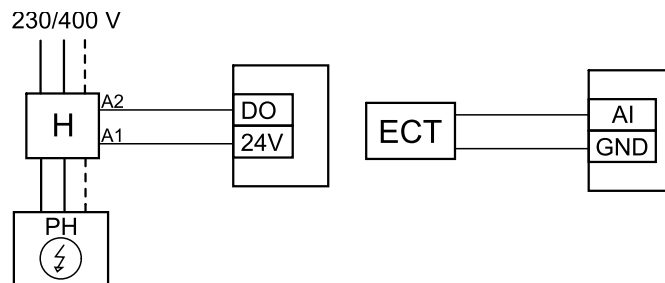

Fig. 14 Pre-heater connections

Configuration

1. Go to `Service` menu
2. Enter password (default 1111)

- Go to **Components** menu, select **Extra Controller** menu and select mode as **Preheater**. Pre-heater setpoint can be set in the same menu. Do other advanced settings if necessary.
- Configure connection of the pre-heater. Go to **Service** menu. Select **Output** menu. In next menu select **DIGITAL** tab. Select the digital output to which the pre-heater connected. Example if it is connected to DO3 on the connection board, then select **DIGITAL OUTPUT 3** and select **Step Controller Y4 Extra Controller** from the output type list.
- Configure extra controller temperature sensor. Go back to **Input** menu. Select **ANALOG** tab. Select the analog input to which the extra controller temperature sensor is connected. Example if it is connected to AI6 on the connection board, then select **ANALOG INPUT 6** and select **Extra Controller Temperature Sensor (ECT)** from the input type list.

11.3.2 Internal water heater

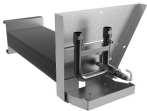

A water heating battery can be installed inside the unit and connected to water system.

- WH – water heating battery
- FPT – frost protection sensor
- SAT – supply air temperature sensor
- S – actuator for valve
- 1 – Outdoor air
- 2 – Supply air
- 3 – Extract air
- 4 – Exhaust air

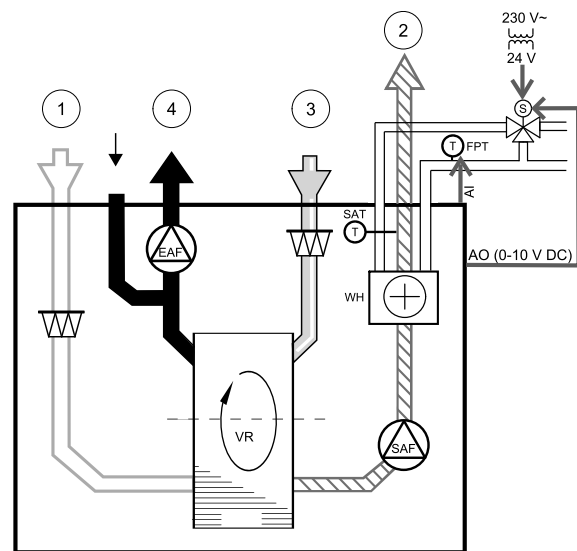

Component/product – Article number:

- Water coil SAVE VTR 300 – 141700
- RVAZ4 24A Actuator 0-10V (S) – 9862
- ZTV 15-0,4 2-way valve – 9829
- ZTV 15-0,6 2-way valve – 6571
- ZTR 15-0,4 valve 3-way – 9670
- ZTR 15-0,6 valve 3-way – 6573

Installation and connection

- Remove plug and add the frost protection sensor. Tread seal the sensor.
- Install water heater in the unit. Connect pipes, 2/3-way valve and actuator.

Important

Do NOT use 24V DC power output from the connection board for valve actuator.

- Connect actuator (S) to any free analog output.

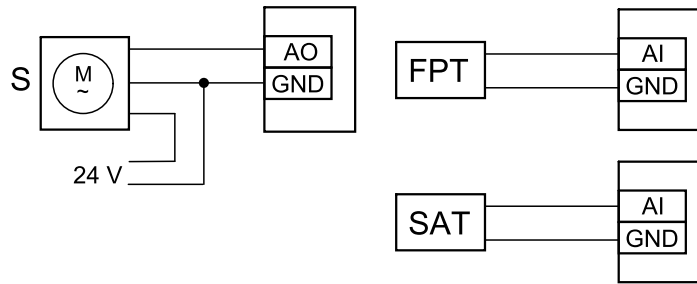

Fig. 15 Water heater connections

Configuration

1. Go to **Service** menu
2. Enter password (default 1111)
3. Activate the actuator. Go to **Components** menu, select **Heater** menu and select type as **water**. Choose actuator voltage type. Do advanced settings if necessary.
4. Configure connection of the water heater. Go to **Service** menu. Select **Output** menu. In next menu select **ANALOG** tab. Select the analog output to which the water heater is connected. Example if it is connected to AO3 on the connection board, then select **ANALOG OUTPUT 3** and select **Y1 Heating** from the output type list.
5. Configure frost protection sensor (FPT). Go back to **Input** menu. Select **ANALOG** tab. Select the analog input to which the frost protection sensor is connected. Example if it is connected to AI6 on the connection board, then select **ANALOG INPUT 6** and select **Frost Protection Temperature Sensor (FPT)** from the input type list.
6. Water heater and its components are now configured.

11.3.3 Duct water heater



A duct water heating battery is supposed to be installed in supply air duct.

- WH – water heating battery
- FPT – frost protection sensor
- SAT – supply air temperature sensor
- S – actuator for valve
- 1 – Outdoor air
- 2 – Supply air
- 3 – Extract air
- 4 – Exhaust air

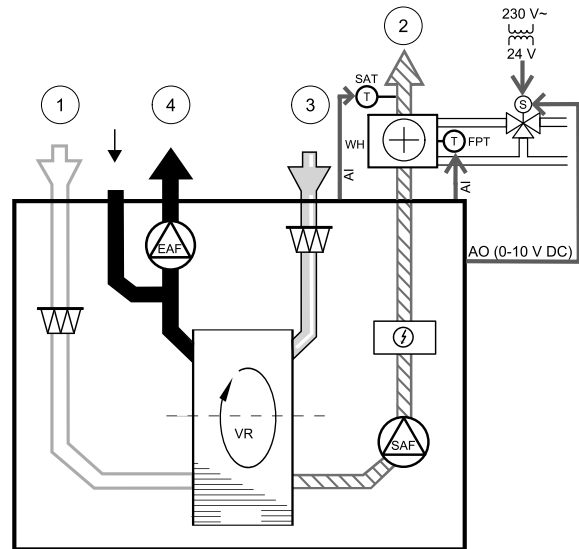

Component/product – Article number:

- VBC 160-2 Water heating battery (2 rows) – 5458
- VBC 160-3 Water heating battery (3 rows) – 9840
- VAZ4 24A Actuator 0-10V (S) – 9862
- ZTV 15-0,4 2-way valve – 9829
- ZTV 15-0,6 2-way valve – 6571
- ZTR 15-0,4 valve 3-way – 9670

- ZTR 15-0,6 valve 3-way – 6573
- Duct sensor -30-70C (SAT) – 211524
- Surface sensor -30-150C (FPT) – 211523

Installation and connection

1. Install water heater in the duct. Connect pipes, 2/3-way valve and actuator.

Important

Do NOT use 24V DC power output from the connection board for valve actuator.

2. Connect actuator (S) to any free analog output.
3. The frost protection sensor (FPT) should be strapped on a surface on the return water pipe. Connect FPT sensor to any free analog input.
4. Internal supply air temperature sensor (SAT, default connection AI2 on the main circuit board) must be replaced by a duct temperature sensor which can be acquired as an accessory. A duct temperature sensor must be installed in the duct after water heater: Connect duct temperature sensor in a place of internal supply air temperature sensor (AI2).



Note:

A duct temperature sensor can be connected to analog inputs 6-7 on the connection board for better access when the internal supply air temperature sensor is disabled in the control panel. Then temperature sensor has to be re-configured as universal analog input.

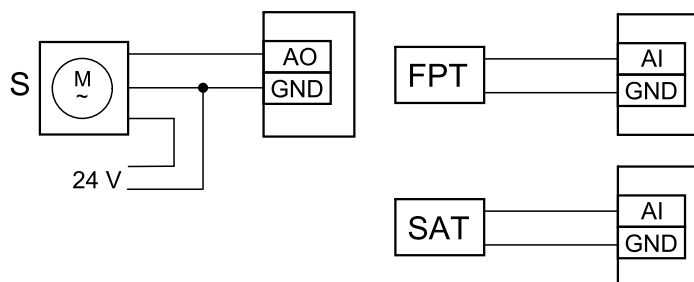

Fig. 16 Water heater connections

Configuration

1. Go to **Service** menu
2. Enter password (default 1111)
3. Activate the actuator. Go to **Components** menu, select **Heater** menu and select type as **Water**. Choose actuator voltage type. Do advanced settings if necessary.
4. Configure connection of the water heater. Go to **Service** menu. Select **Output** menu. In next menu select **ANALOG** tab. Select the analog output to which the water heater is connected. Example if it is connected to AO3 on the connection board, then select **ANALOG OUTPUT 3** and select **Y1 Heating** from the output type list.
5. Configure frost protection sensor (FPT). Go back to **Input** menu. Select **ANALOG** tab. Select the analog input to which the frost protection sensor is connected. Example if it is connected to AI6 on the connection board, then select **ANALOG INPUT 6** and select **Frost Protection Temperature Sensor (FPT)** from the input type list.
6. Since a duct temperature sensor replaces internal supply air temperature sensor, it doesn't need to be re-configured.



Note:

A duct temperature sensor can be connected to analog inputs 6-7 on the connection board for better access when the internal supply air temperature sensor is disabled in the control panel. Then temperature sensor has to be re-configured as universal analog input.

7. Water heater and its components are now configured.

11.3.4 Duct water cooler



A duct water cooler is supposed to be installed in supply air duct to provide a cooled down air to the apartment.

- WC – water cooling battery
- SAT – supply air temperature sensor
- S – valve actuator
- 1 – Outdoor air
- 2 – Supply air
- 3 – Extract air
- 4 – Exhaust air

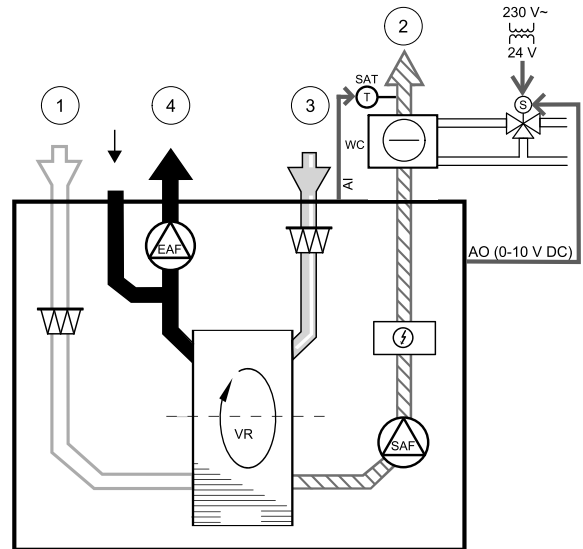

Component/product – Article number:

- CWK 160-3-2,5 Duct cooler,circ – 30022
- RVAZ4 24A Actuator 0-10V (S) – 9862
- ZTV 15-0,4 2-way valve – 9829
- ZTV 15-0,6 2-way valve – 6571
- ZTR 15-0,4 valve 3-way – 9670
- ZTR 15-0,6 valve 3-way – 6573
- Duct sensor -30-70C (SAT) – 211524

Installation and connection

1. Install a duct water cooler in the duct. Connect pipes, 2/3-way valve and actuator.

Important
Do NOT use 24V DC power output from the connection board for valve actuator.

2. Connect actuator (S) to any free analog output.
3. Internal supply air temperature sensor (SAT, default connection AI2 on the main circuit board) must be replaced by a duct temperature sensor which can be acquired as an accessory. A duct temperature sensor must be installed in the duct before water heater: Connect duct temperature sensor in a place of internal supply air temperature sensor.



Note:

A duct temperature sensor can be connected to analog inputs 6-7 on the connection board for better access when the internal supply air temperature sensor is disabled in the control panel.

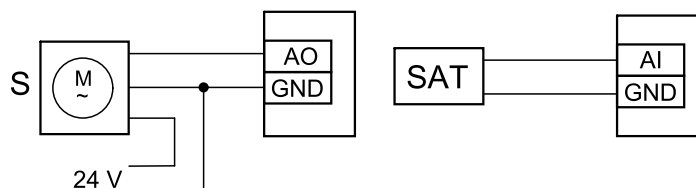

Fig. 17 Duct cooler connections

Configuration

1. Go to **Service** menu
2. Enter password (default 1111)
3. Activate the actuator. Go to **Components** menu, select **COOLER** menu and select type as **water**. Choose actuator voltage type. Do advanced settings if necessary.
4. Configure connection of the duct cooler. Go to **Service** menu. Select **Output** menu. In next menu select **ANALOG** tab. Select the analog output to which the water cooler is connected. Example if it is connected to A03 on the connection board, then select **ANALOG OUTPUT 3** and select **Y3 COOLING** from the output type list.
5. Since a duct temperature sensor replaces internal supply air temperature sensor, it doesn't need to be re-configured.



Note:

A duct temperature sensor can be connected to analog inputs 6–7 on the connection board for better access when the internal supply air temperature sensor is disabled in the control panel. Then temperature sensor has to be re-configured as universal analog input.

6. Duct cooler and its components are now configured.

11.3.5 Change-over coil (DX)

Change-over (DX) coils can be used for both heating and cooling based on the demand.

- DX – change-over coil
- FPT – frost protection sensor (optional)
- SAT – supply air temperature sensor
- THS – thermostat for feedback from pipe if correct temperature available for heating/cooling (optional)
- HP – heat pump (or other device for heating and cooling)
- S – actuator for valve
- 1 – Outdoor air
- 2 – Supply air
- 3 – Extract air
- 4 – Exhaust air

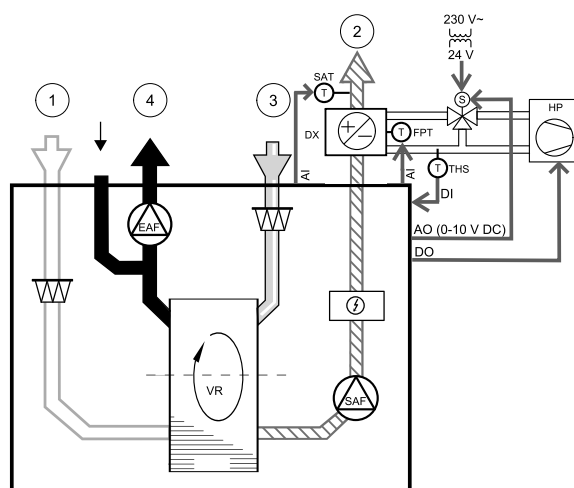

Component/product – Article number:

- RVAZ4 24A Actuator 0-10V (S) – 9862
- ZTV 15-0,4 2-way valve – 9829
- ZTV 15-0,6 2-way valve – 6571
- ZTR 15-0,4 valve 3-way – 9670
- ZTR 15-0,6 valve 3-way – 6573
- Duct sensor -30-70C (SAT) – 211524
- Surface sensor -30-150C (FPT) – 211523

Installation and connection

1. Install water heater in the duct. Connect pipes, 2/3-way valve and actuator.

Important

Do NOT use 24V DC power output from the connection board for valve actuator.

2. Connect actuator (S) to any free analog output.
3. Connect the compressor or other device to any free digital output and 24V.
4. The frost protection sensor (FPT) should be strapped on a surface on the return water pipe. Connect FPT sensor to any free analog input.

- Internal supply air temperature sensor (SAT, default connection AI2 on the main circuit board) must be replaced by a duct temperature sensor which can be acquired as an accessory. A duct temperature sensor must be installed in the duct after water heater: Connect duct temperature sensor in a place of internal supply air temperature sensor (AI2).
- Thermostat can be used to give feedback if correct water temperature available in the pipes (if heating is demanded but only cold water available - heating is interlocked). Configure DI as Change-over feedback. This function is optional.

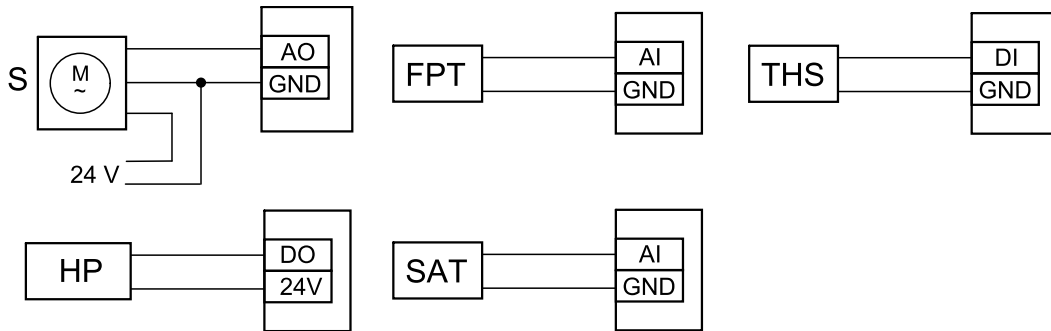

Fig. 18 Change-over heating/cooling connections

Configuration

Before change-over heating/cooling can be activated, it must be configured in the control panel.

- Go to **Service** menu
- Enter password (default 1111)
- Go to **Components** menu, select **Heater** menu and select type as **Change-over**. Choose actuator voltage type. Do advanced settings if necessary.
Go to **Components** menu, select **Cooler** menu and select type as **Change-over**. Choose actuator voltage type. Activate the cooler.
- Configure connection of the change-over heating/cooling actuator. Go to **Service** menu. Select **Output** menu. In next menu select **ANALOG** tab. Select the analog output to which the change-over heater/cooler is connected. Example if it is connected to AO3 on the connection board, then select **ANALOG OUTPUT 3** and select **Y1 / Y3 Change-over** from the output type list.
- Configure frost protection sensor (FPT). Go back to **Input** menu. Select **ANALOG** tab. Select the analog input to which the frost protection sensor is connected. Example if it is connected to AI6 on the connection board, then select **ANALOG INPUT 6** and select **Frost Protection Temperature Sensor (FPT)** from the input type list.
- Configure thermostat for feedback from pipe. Go to **Input** menu. Select **DIGITAL** tab. Select the digital input to which the thermostat for feedback is connected. Example if it is connected to DI2 on the main board, then select **DIGITAL INPUT 2** and select **Change-over feedback** from the input type list. Thermostat for feedback can also be connected to universal input (UI) on the connection board.
- Since a duct temperature sensor replaces internal supply air temperature sensor, it doesn't need to be re-configured.



Note:

A duct temperature sensor can be connected to analog inputs 6-7 on the connection board for better access when the internal supply air temperature sensor is disabled in the control panel. Then temperature sensor has to be re-configured as universal analog input.

- Configure cooling activation signal to the compressor or other device. Go to **Service** menu. Select **Output** menu. In next menu select **DIGITAL** tab. Select the digital output to which the compressor or other device is connected. Example if it is connected to DO3 on the connection board, then select **DIGITAL OUTPUT 3** and select **Activate Cooling** from the output type list.

11.4 Airflow control

11.4.1 VAV/CAV conversion kit

The VAV/CAV conversion kit SAVECair is used for VAV/CAV control of residential units.



Note:

The accessory package contains all needed parts for VAV conversion, however for use with CAV, an IRIS damper or a similar device with known K factor has to be purchased.

Component/product – Article number:

- VAV/CAV conversion kit SAVECair – 140777
- SPI-160 C Iris damper – 6753

Installation and connection

- Follow instructions in the manual which is delivered with the accessory.

11.5 Installation/Maintenance

11.5.1 Outdoor/Exhaust air dampers



If manual fan stop is activated, the unit should be provided with dampers in exhaust and outdoor ducts to avoid cold draught and risk of condensation when the unit has been stopped.

- H – contactor
- U- outdoor air damper
- V – exhaust air damper
- 1 – Outdoor air
- 2 – Supply air
- 3 – Extract air
- 4 – Exhaust air

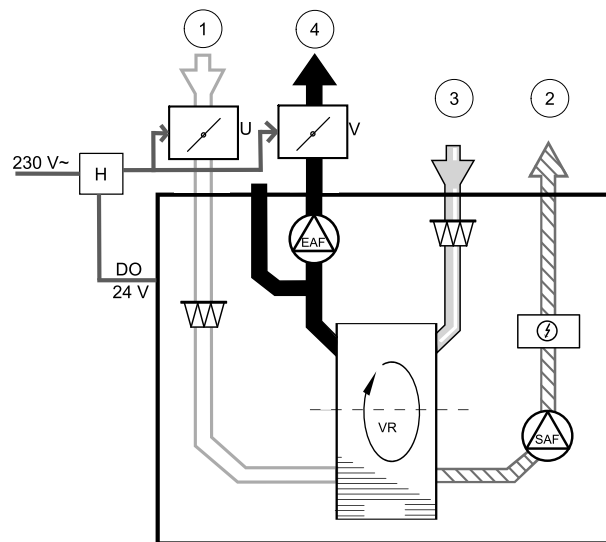

Component/product – Article number:

- TUNE-R-1160-3-M4 (U/V) – 311969
- EFD 160 Damper + TF230 motor – 7122
- Contactor B6 30-10 220-240V 40 – 201519

Installation and connection

1. Install dampers.
2. Connect output of contactor switch (H) to dampers.
3. Connect any free digital output and 24V to control terminals of contactor switch (H).
4. Connect 230 V to input of contactor switch (H).

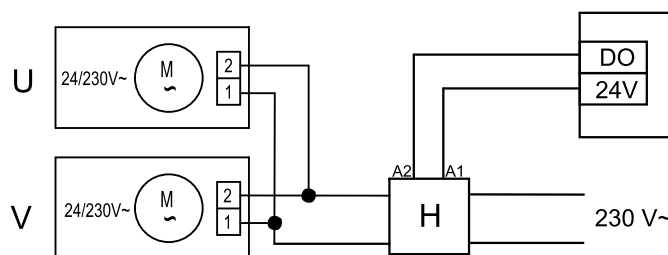

Fig. 19 Damper connection

Configuration

1. Go to `Service` menu
2. Enter password (default 1111)
3. Configure the contactor switch that controls the dampers. Go to `Output` menu. Select `DIGITAL` tab. Select the digital output to which the contactor is connected. Example if it is connected to DO3 on the connection board, then select `DIGITAL OUTPUT 3` and select signal type as `Outdoor-/Exhaust Air Damper` from the output type list.

11.6 Filters

The filters need to be replaced when polluted. New sets of filters, if possible, should be acquired directly from Systemair to meet filter quality standards. If that is not possible, please contact your installer or wholesaler.

The filter type is labelled on the top of the filter

Component/product – Article number:

- BFVTR 300 G3 Supply Air – 208269
- BFVTR 300 G3 Extract Air – 208270
- BFVTR 300 F7 Supply Air – 208268

11.7 Passive House function

To enable Passive House function:

1. Activate Passive House function in menu (HMI or APP). Go to `Service` menu. Enter your password (default 1111). Then go to `Components` menu, select `Heat Exchanger` and turn on `Passive house` function.
2. Install filter kit approved by Passive House Institute (PHI).

Component/product – Article number:

- Filter kit BFVTR 300 – 211587



Systemair UAB
Ling st. 101
LT-20174 Ukmergė, LITHUANIA

Phone +370 340 60165
Fax +370 340 60166

www.systemair.com